

PWM_8B8C

Block User Guide

V01.17

Original Release Date: 12 MAR 1998
Revised: 1 Aug 2004

Motorola Inc.

Motorola reserves the right to make changes without further notice to any products herein to improve reliability, function or design. Motorola does not assume any liability arising out of the application or use of any product or circuit described herein; neither does it convey any license under its patent rights nor the rights of others. Motorola products are not designed, intended, or authorized for use as components in systems intended for surgical implant into the body, or other applications intended to support or sustain life, or for any other application in which the failure of the Motorola product could create a situation where personal injury or death may occur. Should Buyer purchase or use Motorola products for any such unintended or unauthorized application, Buyer shall indemnify and hold Motorola and its officers, employees, subsidiaries, affiliates, and distributors harmless against all claims, costs, damages, and expenses, and reasonable attorney fees arising out of, directly or indirectly, any claim of personal injury or death associated with such unintended or unauthorized use, even if such claim alleges that Motorola was negligent regarding the design or manufacture of the part.

Revision History

Version Number	Revision Date	Effective Date	Author	Description of Changes
00.00		3-12-98		First pass release
00.01		3-15-98		- Updates of Section 1 based on Nancy Thomas peer review and internal spec review. - Added initial information into Section 2.
00.02		4-7-98		- Updates of Section 1 and Section 2 per MSIL review. - Updated cover page per latest spec template review.
01.00		4-15-98		- Updated per Rev. 3.0 TSCS Module Spec Template. - Changed the Port and DDR register names to match the latest HCS12 naming convention. - Added the reset state under each counter, period, and duty register in the Register Description sections. - Added Design for Testability sub-section in Section 2 to describe scan implementation. - Updated Module I/O signal names in Section 2 per the latest HCS12 signal naming convention. - Frozen PWM spec sent to Delco.
01.01		4-30-98		- Added Document Number (12MRE31052W) to cover page of spec per QS9000 requirements. - Changed PWMEN register to PWME and also changed the bit names from PWENx to PWMEEx to follow the enable naming convention. - Changed PWMEN register to PWMCAE and also changed the bit names from CENx to CAEx to avoid having the same register name as the PWMC module. - Section 2 Module I/O list changed to have only 1 input buffer enable signal (pwm_ibe_t4) for the entire port. The reset signal name was also changed to vsc_reset_t4 per the latest bus definition document. - Added further clarification on DISCRW test bit in Section 2. If set, duty and period registers are not loaded with the buffer value.
01.02		5-14-98		- Updated per Rev. 3.1, 3.2 and 3.3 TSCS Module Spec Template. - Removed Table 1-1 PWM Register Address Summary. Added the Address Offset along side the registers in Figure 1-2 PWM Register Map. - Added WARNING regarding writing to the test registers in special modes. - Added footnote regarding the counter value in the Period=0 boundary case. - Removed "weasel" words--may and should.

Version Number	Revision Date	Effective Date	Author	Description of Changes
01.03		5-27-98		<p>Summary of changes:</p> <ul style="list-style-type: none"> - Added clarification on how the counter counts in left and center aligned output modes. - Added further clarification on the Period=0 boundary case. Added that the counter=0. - Added further clarification on what occurs on writes to the counter--output is changed according to the polarity bit. - Added Caution regarding the first PWM cycle after the channel is enabled can be irregular. - Replaced bit 'RDP' with 'RDPPWM' and bit 'PUPP' with 'PUPPWME' to match port control bit naming conventions. - Added 'iam8bit' signal in Table 2-1. - Added Table 2-2, Engineering Electrical Specs. - Added statement in Section 2 regarding DISCRW bit in PWMTST register. When bit is set, the output is not changed according to the polarity bit. - Added statement in Section 2 regarding DISCRM bit in PWMTST register. When bit is set, the duty and period registers do not get loaded with the buffer value. - Corrected left and center aligned max PWM output frequencies in Table A-2. - Created Table A-3 for the PWM Period/Duty Resolution Characteristics. - Miscellaneous clean up.
01.04		7-1-98		<ul style="list-style-type: none"> * Changed reset state of PWMPERx and PWMDTYx registers to FF. * In section 2: changed some bus interface signal names: vsc_wait_t2 changed to vsc_wait_t3 vsc_bdmact_t2 changed to vsc_bdmact_t4 vsc_smod_t2 changed to vsc_smod_t4 * In section 2: Added a note that in concatenated, left aligned, DISCRW=1 writing 16 bit (high-byte-data, low-byte-data) to the counter causes the high byte of the counter to start counting from (high-byte-data) and the low byte of the counter to start counting from (low-byte-data + 1).

Version Number	Revision Date	Effective Date	Author	Description of Changes
01.05		1-6-99		<p>Includes spec tagging in conditional text. There are 3 conditional text tags: Tested- Functional Test (Blue), STATEMENT- Statement (Green), Test Outside Submodule (red).</p> <p>Summary of changes: * Section 1: - Added the following sentence in section 1.6.2.4: When the channel is disabled, writing "0" to the period register will cause the counter to reset on the next selected clock. - Added a caution in section 1.7.15.1 about reading from port register after changing pin to input. - In section 1.9 hanged "Reset state: The prescale free running counter begins to increment" to: "All the channels are disabled and all the counters don't count".</p> <p>* Section 2: - Section 2.2.3 Design for Test: Scan is not implemented on the PWM module. During scan mode (vsc_scanmod = 1) the module is not selected (vsc_pwmssel_t3 = 0) and the module's internal clocks stop. - Table 2-1 PWM Module I/O Signals: Removed scan_e, changed pwm_purst_plug to pwm_puerst_plug, changed vsc_wait_t3 to vsc_wait_t2, changed pwm_outdata_t4[7:0] to pwm_do_t4[7:0], changed pad_indata[7:0] to pwmp_ind[7:0], removed iam8bit, added vsc_en2drv, changed vsc_bdmact_t4 to vsc_bdmact_t2, changed vsc_smod_t4 to vsc_smod_t2. - Added section 2.3.3 and table 2-2 Port Pin Connections. - Section 2.4 table 2-3: Changed Vdd Value to 3 to 3.6v (it was 2.7 to 3.6). Changed System Clock Value to dc to 16MHz (it was 20). - Section 2.4: added Figure 2-7: PWM Timing Diagram. It's like A.6 in the appendix, but includes more details.</p> <p>* Appendix A: Table A-1: System Clock dc to 16MHz (it was 20). Table A-2: E-clock 16MHz (it was 20). A.6 added PWM Timing Diagram.</p>
01.06	09-02-99			<p>* In section 1, Added section 1.7.15 shutdown register(PWMSDN), changed the sec # for the subsequent sections for the registers. * Added emergency shutdown feature in the feature list (sec 1.3) * Added the PWMSDN in the register map (sec 1.5) * Removed \$ _24 from resvd. reg list in sec 1.7.17 * Modified sec 1.12, Interrupt Op., to support the intr. for emergency shutdown, to The PWM module has only one interrupt which is generated at the time of emergency shutdown, if the corresponding enable bit (PWMSDN[6]) is set.</p> <p>* Section 2.2.3: Design for Test: The PWM module will be fully scannable as per the project DFT guidelines * removed GPIO note from section 1.2, 1.3, 1.6.2.1, 1.6.2.7, 1.7.1 * renamed PSBCK to PFRZ in PWMCTL, and removed RDPPWM & PUPPWME bits * changed the interface signals for IP bus. * removed electrical spec details.</p>

Version Number	Revision Date	Effective Date	Author	Description of Changes
01.07		10-25-99		updated the specs after feedback from Munich (removed redundant port signals: ibe, offval, obe[6:0])
01.08		11-25-99		added Global Clock signal to the I/O list. the same is used for reg. writes wherever possible.
01.09		12-08-99		Restart(from shutdown) functionality clarified
01.10		01-17-2000		Tagging Done for Barracuda
01.11		01-25-2000		Tagging for wait mode and freeze mode.
01.12		10-09-2000		format converted for SRS 2.0 compliance.
01.13		19-01-2001		updated section 6.1 and 3.3.1.15 for the shutdown feature changes.
01.14		05-04-2001		Made SRS 2.0 Compliant
01.15		07-19-2001		Document names have been added, Names and Variable definitions have been hidden
01.16		03-14-2002		Syntax corrections, document formal updates
01.17		08-01-2004		Added clarification of PWMIF operation in STOP and WAIT mode. Added notes on minimum pulse width of emergency shutdown signal.

Table 0-1 Revision History

Freescale Semiconductor, Inc.

Table of Contents

Section 1 Introduction

1.1	Overview	13
1.2	Features	13
1.3	Modes of Operation	13
1.4	Block Diagram	13

Section 2 PWM8b8cSignal Description

2.1	Overview	15
2.2	Detailed Signal Descriptions	15
2.2.1	PWM7 — PWM8b8c Channel 7	15
2.2.2	PWM6 — PWM8b8c Channel 6	15
2.2.3	PWM5 — PWM8b8c Channel 5	15
2.2.4	PWM4 — PWM8b8c Channel 4	15
2.2.5	PWM3 — PWM8b8c Channel 3	15
2.2.6	PWM2 — PWM8b8c Channel 2	15
2.2.7	PWM1 — PWM8b8c Channel 1	15
2.2.8	PWM0 — PWM8b8c Channel 0	15

Section 3 Memory Map and Register Definition

3.1	Overview	17
3.2	Module Memory Map	17
3.3	Register Descriptions	18
3.3.1	PWM Enable Register (PWME)	18
3.3.2	PWM Polarity Register (PWMPOL)	20
3.3.3	PWM Clock Select Register (PWMCLK)	21
3.3.4	PWM Prescale Clock Select Register (PWMPRCLK)	23
3.3.5	PWM Center Align Enable Register (PWMCAE)	24
3.3.6	PWM Control Register (PWMCTL)	25
3.3.7	Reserved Register (PWMTST)	27
3.3.8	Reserved Register (PWMPRSC)	27
3.3.9	PWM Scale A Register (PWMSCLA)	28
3.3.10	PWM Scale B Register (PWMSCLB)	28
3.3.11	Reserved Registers (PWMSCNTx)	29

3.3.12	PWM Channel Counter Registers (PWMCNTx)	29
3.3.13	PWM Channel Period Registers (PWMPERx)	30
3.3.14	PWM Channel Duty Registers (PWMDTYx)	31
3.3.15	PWM Shutdown Register (PWMSDN)	33

Section 4 Functional Description

4.1	PWM Clock Select	35
4.1.1	Prescale	37
4.1.2	Clock Scale	37
4.1.3	Clock Select	38
4.2	PWM Channel Timers	38
4.2.1	PWM Enable	39
4.2.2	PWM Polarity	39
4.2.3	PWM Period and Duty	40
4.2.4	PWM Timer Counters	40
4.2.5	Left Aligned Outputs	41
4.2.6	Center Aligned Outputs	43
4.2.7	PWM 16-Bit Functions	44
4.2.8	PWM Boundary Cases	47

Section 5 Resets

5.1	General	49
-----	-------------------	----

Section 6 Interrupts

6.1	Interrupt Operation	51
-----	-------------------------------	----

List of Figures

Figure 1-1	PWM_8B8C Block Diagram	14
Figure 3-1	PWM Enable Register (PWME)	19
Figure 3-2	PWM Polarity Register (PWMPOL)	20
Figure 3-3	PWM Clock Select Register (PWMCLK)	22
Figure 3-4	PWM Prescale Clock Select Register (PWMPRCLK)	23
Figure 3-5	PWM Center Align Enable Register (PWMCAE)	24
Figure 3-6	PWM Control Register (PWMCTL)	25
Figure 3-7	Reserved Register (PWMTST)	27
Figure 3-8	Reserved Register (PWMPRSC)	27
Figure 3-9	PWM Scale A Register (PWMSCLA)	28
Figure 3-10	PWM Scale B Register (PWMSCLB)	29
Figure 3-11	Reserved Registers (PWMSCNTx)	29
Figure 3-12	PWM Channel Counter Registers (PWMCNTx)	30
Figure 3-13	PWM Channel Period Registers (PWMPERx)	31
Figure 3-14	PWM Channel Duty Registers (PWMDTYx)	32
Figure 3-15	PWM Shutdown Register (PWMSDN)	33
Figure 4-1	PWM Clock Select Block Diagram	36
Figure 4-2	PWM Timer Channel Block Diagram	39
Figure 4-3	PWM Left Aligned Output Waveform	42
Figure 4-4	PWM Left Aligned Output Example Waveform	42
Figure 4-5	PWM Center Aligned Output Waveform	43
Figure 4-6	PWM Center Aligned Output Example Waveform	44
Figure 4-7	PWM 16-Bit Mode	45

Freescale Semiconductor, Inc.

List of Tables

Table 0-1	Revision History	5
Table 3-1	PWM_8B8C Memory Map	17
Table 3-2	Clock B Prescaler Selects	23
Table 3-3	Clock A Prescaler Selects	24
Table 4-1	PWM Timer Counter Conditions	41
Table 4-2	16-bit Concatenation Mode Summary	46
Table 4-3	PWM Boundary Cases.	47

Freescale Semiconductor, Inc.

Section 1 Introduction

1.1 Overview

The PWM_8B8C definition is based on the HC12 PWM definitions. This PWM_8B8C contains the basic features from the HC11 with some of the enhancements incorporated on the HC12., that is center aligned output mode and four available clock sources. The PWM_8B8C module has eight channels with independent control of left and center aligned outputs on each channel.

Each of the eight channels has a programmable period and duty cycle as well as a dedicated counter. A flexible clock select scheme allows a total of four different clock sources to be used with the counters. Each of the modulators can create independent continuous waveforms with software-selectable duty rates from 0% to 100%. The PWM outputs can be programmed as left aligned outputs or center aligned outputs.

1.2 Features

The block includes these distinctive features:

- Eight independent PWM channels with programmable period and duty cycle.
- Dedicated counter for each PWM channel.
- Programmable PWM enable/disable for each channel.
- Software selection of PWM duty pulse polarity for each channel.
- Period and duty cycle are double buffered. Change takes effect when the end of the effective period is reached (PWM counter reaches zero) or when the channel is disabled.
- Programmable center or left aligned outputs on individual channels.
- Eight 8-bit channel or four 16-bit channel PWM resolution.
- Four clock sources (A, B, SA and SB) provide for a wide range of frequencies.
- Programmable Clock Select Logic.
- Emergency shutdown.

1.3 Modes of Operation

There is a software programmable option for low power consumption in Wait mode that disables the input clock to the prescaler.

In freeze mode there is a software programmable option to disable the input clock to the prescaler. This is useful for emulation.

1.4 Block Diagram

Figure 1-1 shows the block diagram for the 8-bit 8-channel PWM_8B8C block.

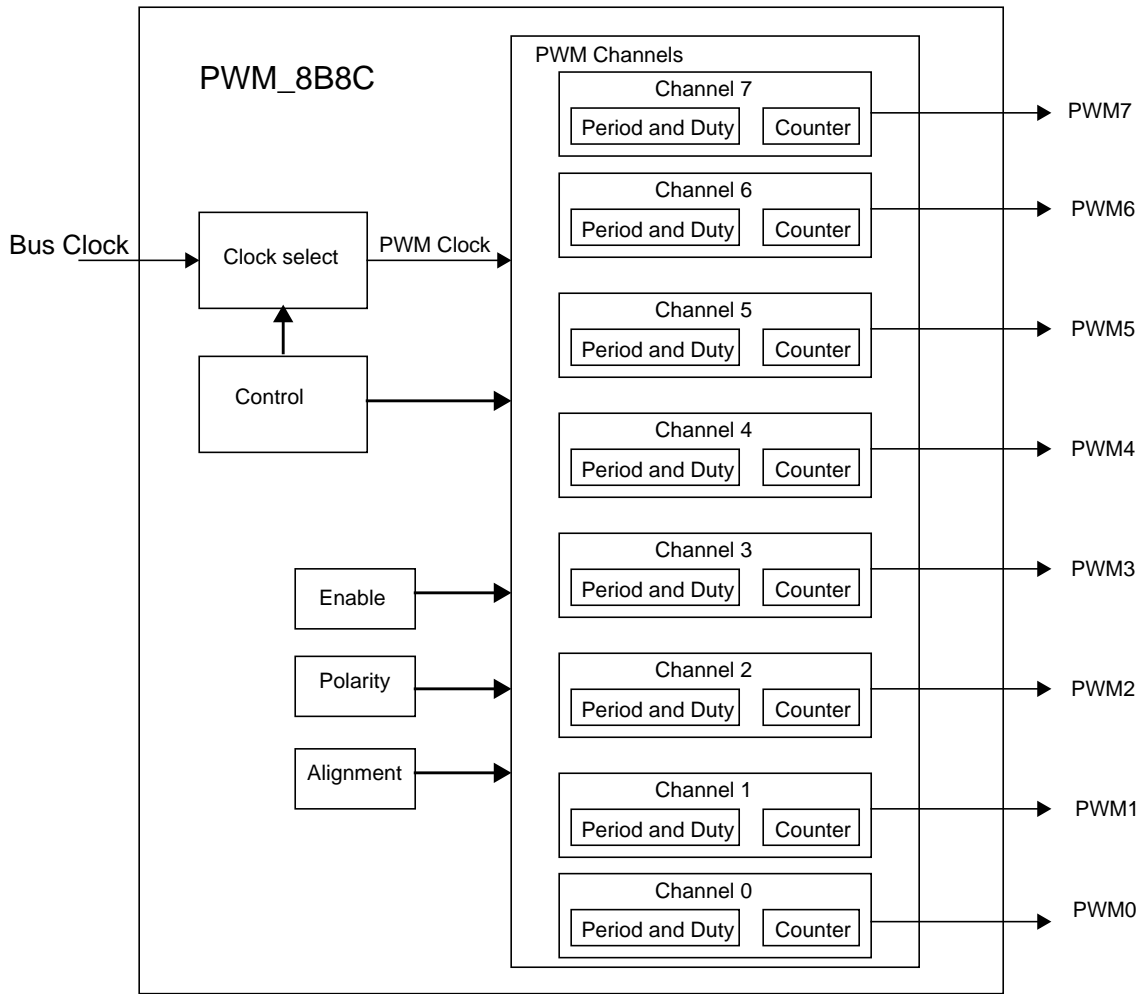

Figure 1-1 PWM_8B8C Block Diagram

Section 2 PWM8b8c Signal Description

2.1 Overview

The PWM_8B8C module has a total of 8 external pins.

2.2 Detailed Signal Descriptions

2.2.1 PWM7 — PWM8b8c Channel 7

This pin serves as waveform output of PWM channel 7 and as an input for the emergency shutdown feature.

2.2.2 PWM6 — PWM8b8c Channel 6

This pin serves as waveform output of PWM channel 6.

2.2.3 PWM5 — PWM8b8c Channel 5

This pin serves as waveform output of PWM channel 5.

2.2.4 PWM4 — PWM8b8c Channel 4

This pin serves as waveform output of PWM channel 4.

2.2.5 PWM3 — PWM8b8c Channel 3

This pin serves as waveform output of PWM channel 3.

2.2.6 PWM2 — PWM8b8c Channel 2

This pin serves as waveform output of PWM channel 2.

2.2.7 PWM1 — PWM8b8c Channel 1

This pin serves as waveform output of PWM channel 1.

2.2.8 PWM0 — PWM8b8c Channel 0

This pin serves as waveform output of PWM channel 0.

Section 3 Memory Map and Register Definition

3.1 Overview

This section describes in detail all the registers and register bits in the PWM_8B8C module.

The special-purpose registers and register bit functions that would not normally be made available to device end users, such as factory test control registers and reserved registers are clearly identified by means of shading the appropriate portions of address maps and register diagrams. Notes explaining the reasons for restricting access to the registers and functions are also explained in the individual register descriptions.

3.2 Module Memory Map

This section describes the content of the registers in the PWM_8B8C module. The base address of the PWM_8B8C module is determined at the MCU level when the MCU is defined. The register decode map is fixed and begins at the first address of the module address offset. The figure below shows the registers associated with the PWM and their relative offset from the base address. The register detail description follows the order they appear in the register map.

Reserved bits within a register will always read as 0 and the write will be unimplemented. Unimplemented functions are indicated by shading the bit.

Table 3-1 shows the memory map for the PWM_8B8C module

Table 3-1 PWM_8B8C Memory Map

Address	Use	Access
\$_00	PWM Enable Register (PWME)	R/W
\$_01	PWM Polarity Register (PWMPOL)	R/W
\$_02	PWM Clock Select Register (PWMCLK)	R/W
\$_03	PWM Prescale Clock Select Register (PWMPRCLK)	R/W
\$_04	PWM Center Align Enable Register (PWMCAE)	R/W
\$_05	PWM Control Register (PWMCTL)	R/W
\$_06	PWM Test Register (PWMTST) ¹	R/W
\$_07	PWM Prescale Counter Register (PWMPRSC) ²	R/W
\$_08	PWM Scale A Register (PWMSCLA)	R/W
\$_09	PWM Scale B Register (PWMSCLB)	R/W
\$_0A	PWM Scale A Counter Register (PWMSCNTA) ³	R/W
\$_0B	PWM Scale B Counter Register (PWMSCNTB) ⁴	R/W
\$_0C	PWM Channel 0 Counter Register (PWMCNT0)	R/W
\$_0D	PWM Channel 1 Counter Register (PWMCNT1)	R/W
\$_0E	PWM Channel 2 Counter Register (PWMCNT2)	R/W
\$_0F	PWM Channel 3 Counter Register (PWMCNT3)	R/W
\$_10	PWM Channel 4 Counter Register (PWMCNT4)	R/W
\$_11	PWM Channel 5 Counter Register (PWMCNT5)	R/W
\$_12	PWM Channel 6 Counter Register (PWMCNT6)	R/W

Table 3-1 PWM_8B8C Memory Map

\$_13	PWM Channel 7 Counter Register (PWMCNT7)	R/W
\$_14	PWM Channel 0 Period Register (PWMPER0)	R/W
\$_15	PWM Channel 1 Period Register (PWMPER1)	R/W
\$_16	PWM Channel 2 Period Register (PWMPER2)	R/W
\$_17	PWM Channel 3 Period Register (PWMPER3)	R/W
\$_18	PWM Channel 4 Period Register (PWMPER4)	R/W
\$_19	PWM Channel 5 Period Register (PWMPER5)	R/W
\$_1A	PWM Channel 6 Period Register (PWMPER6)	R/W
\$_1B	PWM Channel 7 Period Register (PWMPER7)	R/W
\$_1C	PWM Channel 0 Duty Register (PWMDTY0)	R/W
\$_1D	PWM Channel 1 Duty Register (PWMDTY1)	R/W
\$_1E	PWM Channel 2 Duty Register (PWMDTY2)	R/W
\$_1F	PWM Channel 3 Duty Register (PWMDTY3)	R/W
\$_20	PWM Channel 4 Duty Register (PWMDTY4)	R/W
\$_21	PWM Channel 5 Duty Register (PWMDTY5)	R/W
\$_22	PWM Channel 6 Duty Register (PWMDTY6)	R/W
\$_23	PWM Channel 7 Duty Register (PWMDTY7)	R/W
\$_24	PWM Shutdown Register (PWMSDN)	R/W
\$_25	Reserved	R
\$_26	Reserved	R
\$_27	Reserved	R

NOTES:

1. PWMTST is intended for factory test purposes only.
2. PWMPRSC is intended for factory test purposes only.
3. PWMSCNTA is intended for factory test purposes only.
4. PWMSCNTB is intended for factory test purposes only.

NOTE: Register Address = Base Address + Address Offset, where the Base Address is defined at the MCU level and the Address Offset is defined at the module level.

3.3 Register Descriptions

This section describes in detail all the registers and register bits in the PWM_8B8C module.

3.3.1 PWM Enable Register (PWME)

Each PWM channel has an enable bit (PWME_x) to start its waveform output. When any of the PWME_x bits are set (PWME_x=1), the associated PWM output is enabled immediately. However, the actual PWM waveform is not available on the associated PWM output until its clock source begins its next cycle due to the synchronization of PWME_x and the clock source.

NOTE: The first PWM cycle after enabling the channel can be irregular.

An exception to this is when channels are concatenated. Once concatenated mode is enabled (CON_{xx} bits set in PWMCTL register) then enabling/disabling the corresponding 16-bit PWM channel is controlled by

the low order PWME_x bit. In this case, the high order bytes PWME_x bits have no effect and their corresponding PWM output lines are disabled.

While in run mode, if all eight PWM channels are disabled (PWME7-0=0), the prescaler counter shuts off for power savings.

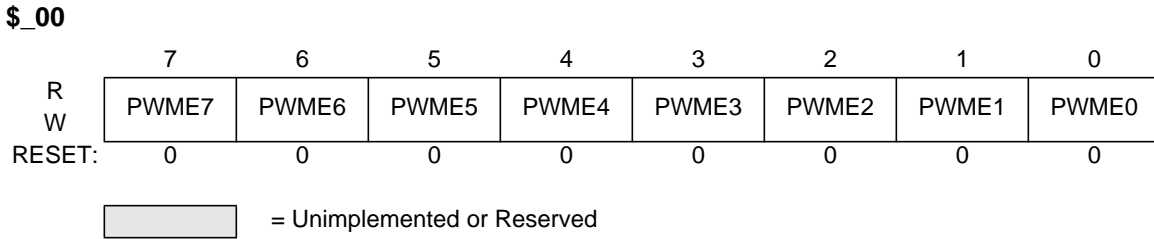

Figure 3-1 PWM Enable Register (PWME)

Read: anytime

Write: anytime

PWME7 — Pulse Width Channel 7 Enable

- 1 = Pulse Width channel 7 is enabled. The pulse modulated signal becomes available at PWM output bit7 when its clock source begins its next cycle.
- 0 = Pulse Width channel 7 is disabled.

PWME6 — Pulse Width Channel 6 Enable

- 1 = Pulse Width channel 6 is enabled. The pulse modulated signal becomes available at PWM output bit6 when its clock source begins its next cycle. If CON67=1, then bit has no effect and PWM output line6 is disabled.
- 0 = Pulse Width channel 6 is disabled.

PWME5 — Pulse Width Channel 5 Enable

- 1 = Pulse Width channel 5 is enabled. The pulse modulated signal becomes available at PWM output bit 5 when its clock source begins its next cycle.
- 0 = Pulse Width channel 5 is disabled.

PWME4 — Pulse Width Channel 4 Enable

- 1 = Pulse Width channel 4 is enabled. The pulse modulated signal becomes available at PWM, output bit 4 when its clock source begins its next cycle. If CON45=1, then bit has no effect and PWM output bit4 is disabled.
- 0 = Pulse Width channel 4 is disabled.

PWME3 — Pulse Width Channel 3 Enable

- 1 = Pulse Width channel 3 is enabled. The pulse modulated signal becomes available at PWM, output bit 3 when its clock source begins its next cycle.
- 0 = Pulse Width channel 3 is disabled.

PWME2 — Pulse Width Channel 2 Enable

- 1 = Pulse Width channel 2 is enabled. The pulse modulated signal becomes available at PWM, output bit 2 when its clock source begins its next cycle. If CON23=1, then bit has no effect and PWM output bit2 is disabled.
- 0 = Pulse Width channel 2 is disabled.

PWME1 — Pulse Width Channel 1 Enable

- 1 = Pulse Width channel 1 is enabled. The pulse modulated signal becomes available at PWM, output bit 1 when its clock source begins its next cycle.
- 0 = Pulse Width channel 1 is disabled.

PWME0 — Pulse Width Channel 0 Enable

- 1 = Pulse Width channel 0 is enabled. The pulse modulated signal becomes available at PWM, output bit 0 when its clock source begins its next cycle. If CON01=1, then bit has no effect and PWM output line0 is disabled.
- 0 = Pulse Width channel 0 is disabled.

3.3.2 PWM Polarity Register (PWMPOL)

The starting polarity of each PWM channel waveform is determined by the associated PPOLx bit in the PWMPOL register. If the polarity bit is one, the PWM channel output is high at the beginning of the cycle and then goes low when the duty count is reached. Conversely, if the polarity bit is zero, the output starts low and then goes high when the duty count is reached.

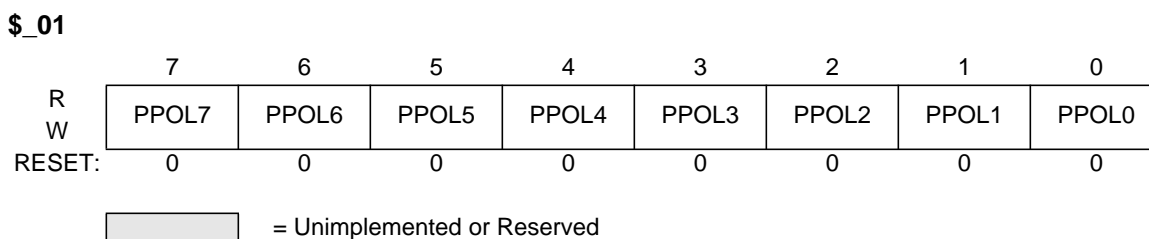

Figure 3-2 PWM Polarity Register (PWMPOL)

Read: anytime

Write: anytime

NOTE: *PPOLx register bits can be written anytime. If the polarity is changed while a PWM signal is being generated, a truncated or stretched pulse can occur during the transition*

PPOL7 — Pulse Width Channel 7 Polarity

- 1 = PWM channel 7 output is high at the beginning of the period, then goes low when the duty count is reached.
- 0 = PWM channel 7 output is low at the beginning of the period, then goes high when the duty count is reached.

PPOL6 — Pulse Width Channel 6 Polarity

- 1 = PWM channel 6 output is high at the beginning of the period, then goes low when the duty count is reached.
- 0 = PWM channel 6 output is low at the beginning of the period, then goes high when the duty count is reached.

PPOL5 — Pulse Width Channel 5 Polarity

- 1 = PWM channel 5 output is high at the beginning of the period, then goes low when the duty count is reached.
- 0 = PWM channel 5 output is low at the beginning of the period, then goes high when the duty count is reached.

PPOL4 — Pulse Width Channel 4 Polarity

- 1 = PWM channel 4 output is high at the beginning of the period, then goes low when the duty count is reached.
- 0 = PWM channel 4 output is low at the beginning of the period, then goes high when the duty count is reached.

PPOL3 — Pulse Width Channel 3 Polarity

- 1 = PWM channel 3 output is high at the beginning of the period, then goes low when the duty count is reached.
- 0 = PWM channel 3 output is low at the beginning of the period, then goes high when the duty count is reached.

PPOL2 — Pulse Width Channel 2 Polarity

- 1 = PWM channel 2 output is high at the beginning of the period, then goes low when the duty count is reached.
- 0 = PWM channel 2 output is low at the beginning of the period, then goes high when the duty count is reached.

PPOL1 — Pulse Width Channel 1 Polarity

- 1 = PWM channel 1 output is high at the beginning of the period, then goes low when the duty count is reached.
- 0 = PWM channel 1 output is low at the beginning of the period, then goes high when the duty count is reached.

PPOL0 — Pulse Width Channel 0 Polarity

- 1 = PWM channel 0 output is high at the beginning of the period, then goes low when the duty count is reached.
- 0 = PWM channel 0 output is low at the beginning of the period, then goes high when the duty count is reached.

3.3.3 PWM Clock Select Register (PWMCLK)

Each PWM channel has a choice of two clocks to use as the clock source for that channel as described below.

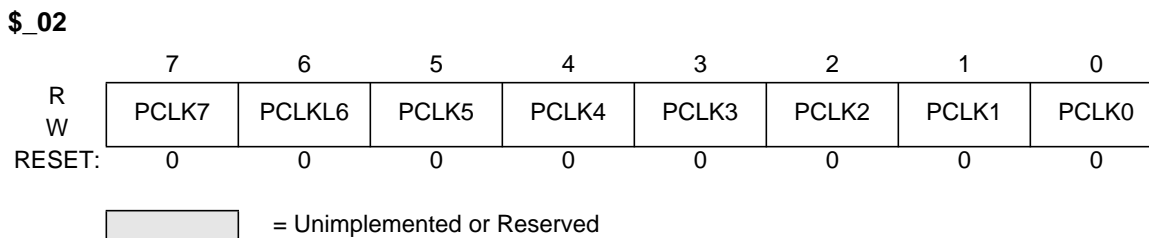

Figure 3-3 PWM Clock Select Register (PWMCLK)

Read: anytime

Write: anytime

NOTE: Register bits PCLK0 to PCLK7 can be written anytime. If a clock select is changed while a PWM signal is being generated, a truncated or stretched pulse can occur during the transition.

PCLK7 — Pulse Width Channel 7 Clock Select

- 1 = Clock SB is the clock source for PWM channel 7.
- 0 = Clock B is the clock source for PWM channel 7.

PCLK6 — Pulse Width Channel 6 Clock Select

- 1 = Clock SB is the clock source for PWM channel 6.
- 0 = Clock B is the clock source for PWM channel 6.

PCLK5 — Pulse Width Channel 5 Clock Select

- 1 = Clock SA is the clock source for PWM channel 5.
- 0 = Clock A is the clock source for PWM channel 5.

PCLK4 — Pulse Width Channel 4 Clock Select

- 1 = Clock SA is the clock source for PWM channel 4.
- 0 = Clock A is the clock source for PWM channel 4.

PCLK3 — Pulse Width Channel 3 Clock Select

- 1 = Clock SB is the clock source for PWM channel 3.
- 0 = Clock B is the clock source for PWM channel 3.

PCLK2 — Pulse Width Channel 2 Clock Select

- 1 = Clock SB is the clock source for PWM channel 2.
- 0 = Clock B is the clock source for PWM channel 2.

PCLK1 — Pulse Width Channel 1 Clock Select

- 1 = Clock SA is the clock source for PWM channel 1.
- 0 = Clock A is the clock source for PWM channel 1.

PCLK0 — Pulse Width Channel 0 Clock Select

- 1 = Clock SA is the clock source for PWM channel 0.

0 = Clock A is the clock source for PWM channel 0.

3.3.4 PWM Prescale Clock Select Register (PWMPRCLK)

This register selects the prescale clock source for clocks A and B independently.

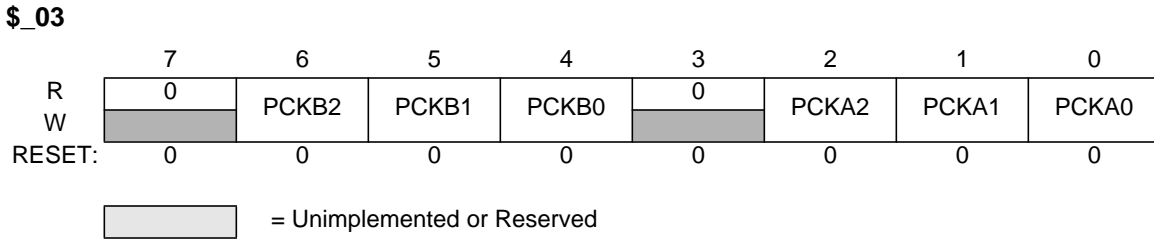

Figure 3-4 PWM Prescale Clock Select Register (PWMPRCLK)

Read: anytime

Write: anytime

NOTE: *PCKB2-0 and PCKA2-0 register bits can be written anytime. If the clock pre-scale is changed while a PWM signal is being generated, a truncated or stretched pulse can occur during the transition.*

PCKB2 - PCKB0 — Prescaler Select for Clock B

Clock B is one of two clock sources which can be used for channels 2, 3, 6 or 7. These three bits determine the rate of clock B, as shown in the following table.

Table 3-2 Clock B Prescaler Selects

PCKB2	PCKB1	PCKB0	Value of Clock B
0	0	0	bus clock
0	0	1	bus clock / 2
0	1	0	bus clock / 4
0	1	1	bus clock / 8
1	0	0	bus clock / 16
1	0	1	bus clock / 32
1	1	0	bus clock / 64
1	1	1	bus clock / 128

PCKA2 - PCKA0 — Prescaler Select for Clock A

Clock A is one of two clock sources which can be used for channels 0, 1, 4 or 5. These three bits determine the rate of clock A, as shown in the following table.

Table 3-3 Clock A Prescaler Selects

PCKA2	PCKA1	PCKA0	Value of Clock A
0	0	0	bus clock
0	0	1	bus clock / 2
0	1	0	bus clock / 4
0	1	1	bus clock / 8
1	0	0	bus clock / 16
1	0	1	bus clock / 32
1	1	0	bus clock / 64
1	1	1	bus clock / 128

3.3.5 PWM Center Align Enable Register (PWMCAE)

The PWMCAE register contains eight control bits for the selection of center aligned outputs or left aligned outputs for each PWM channel. If the CAEx bit is set to a one, the corresponding PWM output will be center aligned. If the CAEx bit is cleared, the corresponding PWM output will be left aligned. Reference **4.2.5 Left Aligned Outputs** and **4.2.6 Center Aligned Outputs** for a more detailed description of the PWM output modes.

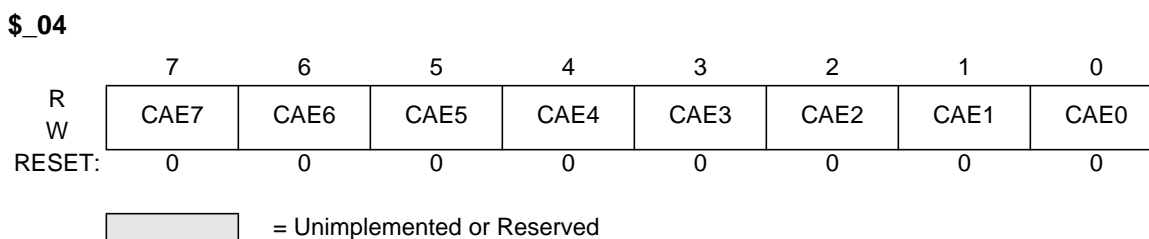

Figure 3-5 PWM Center Align Enable Register (PWMCAE)

Read: anytime

Write: anytime

NOTE: Write these bits only when the corresponding channel is disabled.

CAE7 — Center Aligned Output Mode on channel 7
 1 = Channel 7 operates in Center Aligned Output Mode.
 0 = Channel 7 operates in Left Aligned Output Mode.

CAE6 — Center Aligned Output Mode on channel 6

- 1 = Channel 6 operates in Center Aligned Output Mode.
- 0 = Channel 6 operates in Left Aligned Output Mode.

CAE5 — Center Aligned Output Mode on channel 5
 1 = Channel 5 operates in Center Aligned Output Mode.
 0 = Channel 5 operates in Left Aligned Output Mode.

CAE4 — Center Aligned Output Mode on channel 4
 1 = Channel 4 operates in Center Aligned Output Mode.
 0 = Channel 4 operates in Left Aligned Output Mode.

CAE3 — Center Aligned Output Mode on channel 3
 1 = Channel 3 operates in Center Aligned Output Mode.
 0 = Channel 3 operates in Left Aligned Output Mode.

CAE2 — Center Aligned Output Mode on channel 2
 1 = Channel 2 operates in Center Aligned Output Mode.
 0 = Channel 2 operates in Left Aligned Output Mode.

CAE1 — Center Aligned Output Mode on channel 1
 1 = Channel 1 operates in Center Aligned Output Mode.
 0 = Channel 1 operates in Left Aligned Output Mode.

CAE0 — Center Aligned Output Mode on channel 0
 1 = Channel 0 operates in Center Aligned Output Mode.
 0 = Channel 0 operates in Left Aligned Output Mode.

3.3.6 PWM Control Register (PWMCTL)

The PWMCTL register provides for various control of the PWM module.

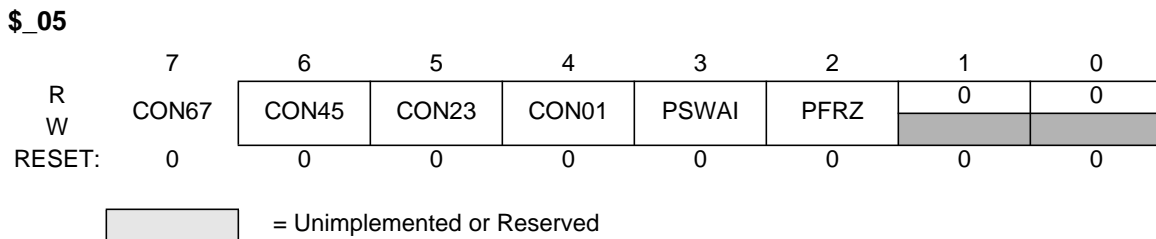

Figure 3-6 PWM Control Register (PWMCTL)

Read: anytime

Write: anytime

There are three control bits for concatenation, each of which is used to concatenate a pair of PWM channels into one 16-bit channel. When channels 6 and 7 are concatenated, channel 6 registers become the high order bytes of the double byte channel. When channels 4 and 5 are concatenated, channel 4 registers

become the high order bytes of the double byte channel. When channels 2 and 3 are concatenated, channel 2 registers become the high order bytes of the double byte channel. When channels 0 and 1 are concatenated, channel 0 registers become the high order bytes of the double byte channel.

Reference **4.2.7 PWM 16-Bit Functions** for a more detailed description of the concatenation PWM Function.

NOTE: *Change these bits only when both corresponding channels are disabled.*

CON67 — Concatenate channels 6 and 7

1 = Channels 6 and 7 are concatenated to create one 16-bit PWM channel. Channel 6 becomes the high order byte and channel 7 becomes the low order byte. Channel 7 output pin is used as the output for this 16-bit PWM (bit 7 of port PWMP). Channel 7 clock select control-bit determines the clock source, channel 7 polarity bit determines the polarity, channel 7 enable bit enables the output and channel 7 center aligned enable bit determines the output mode.

0 = Channels 6 and 7 are separate 8-bit PWMs.

CON45 — Concatenate channels 4 and 5

1 = Channels 4 and 5 are concatenated to create one 16-bit PWM channel. Channel 4 becomes the high order byte and channel 5 becomes the low order byte. Channel 5 output pin is used as the output for this 16-bit PWM (bit 5 of port PWMP). Channel 5 clock select control-bit determines the clock source, channel 5 polarity bit determines the polarity, channel 5 enable bit enables the output and channel 5 center aligned enable bit determines the output mode.

0 = Channels 4 and 5 are separate 8-bit PWMs.

CON23 — Concatenate channels 2 and 3

1 = Channels 2 and 3 are concatenated to create one 16-bit PWM channel. Channel 2 becomes the high order byte and channel 3 becomes the low order byte. Channel 3 output pin is used as the output for this 16-bit PWM (bit 3 of port PWMP). Channel 3 clock select control-bit determines the clock source, channel 3 polarity bit determines the polarity, channel 3 enable bit enables the output and channel 3 center aligned enable bit determines the output mode.

0 = Channels 2 and 3 are separate 8-bit PWMs.

CON01 — Concatenate channels 0 and 1

1 = Channels 0 and 1 are concatenated to create one 16-bit PWM channel. Channel 0 becomes the high order byte and channel 1 becomes the low order byte. Channel 1 output pin is used as the output for this 16-bit PWM (bit 1 of port PWMP). Channel 1 clock select control-bit determines the clock source, channel 1 polarity bit determines the polarity, channel 1 enable bit enables the output and channel 1 center aligned enable bit determines the output mode.

0 = Channels 0 and 1 are separate 8-bit PWMs.

PSWAI — PWM Stops in Wait Mode

Enabling this bit allows for lower power consumption in Wait Mode by disabling the input clock to the prescaler.

1 = Stop the input clock to the prescaler whenever the MCU is in Wait Mode.

0 = Allow the clock to the prescaler to continue while in wait mode.

PFRZ — PWM Counters Stop in Freeze Mode

In Freeze Mode, there is an option to disable the input clock to the prescaler by setting the PFRZ bit in the PWMCTL register. If this bit is set, whenever the MCU is in freeze mode the input clock to the prescaler is disabled. This feature is useful during emulation as it allows the PWM function to be suspended. In this way, the counters of the PWM can be stopped while in freeze mode so that once normal program flow is continued, the counters are re-enabled to simulate real-time operations. Since the registers can still be accessed in this mode, to re-enable the prescaler clock, either disable the PFRZ bit or exit freeze mode.

- 1 = Disable PWM input clock to the prescaler whenever the part is in freeze mode. This is useful for emulation.
- 0 = Allow PWM to continue while in freeze mode.

3.3.7 Reserved Register (PWMTST)

This register is reserved for factory testing of the PWM module and is not available in normal modes.

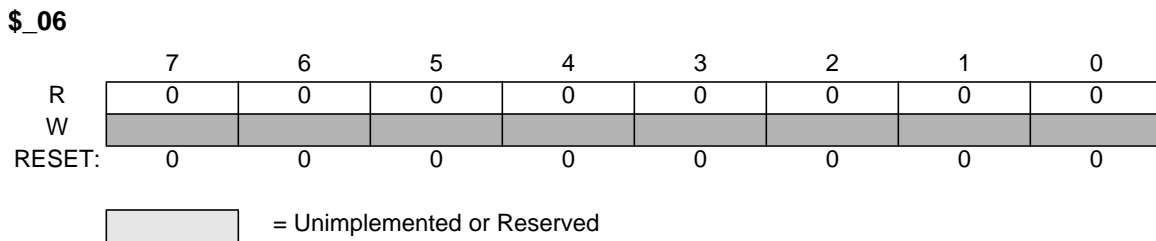

Figure 3-7 Reserved Register (PWMTST)

Read: always read \$00 in normal modes

Write: unimplemented in normal modes

NOTE: Writing to this register when in special modes can alter the PWM functionality.

3.3.8 Reserved Register (PWMPRSC)

This register is reserved for factory testing of the PWM module and is not available in normal modes.

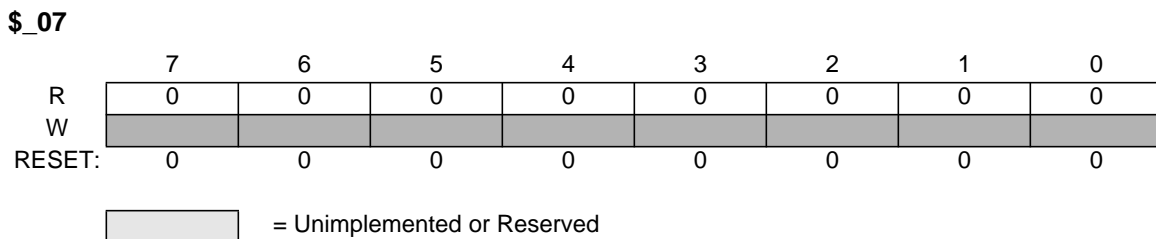

Figure 3-8 Reserved Register (PWMPRSC)

Read: always read \$00 in normal modes

Write: unimplemented in normal modes

NOTE: Writing to this register when in special modes can alter the PWM functionality.

3.3.9 PWM Scale A Register (PWMSCLA)

PWMSCLA is the programmable scale value used in scaling clock A to generate clock SA. Clock SA is generated by taking clock A, dividing it by the value in the PWMSCLA register and dividing that by two.

$$\text{Clock SA} = \text{Clock A} / (2 * \text{PWMSCLA})$$

NOTE: When PWMSCLA = \$00, PWMSCLA value is considered a full scale value of 256. Clock A is thus divided by 512.

Any value written to this register will cause the scale counter to load the new scale value (PWMSCLA).

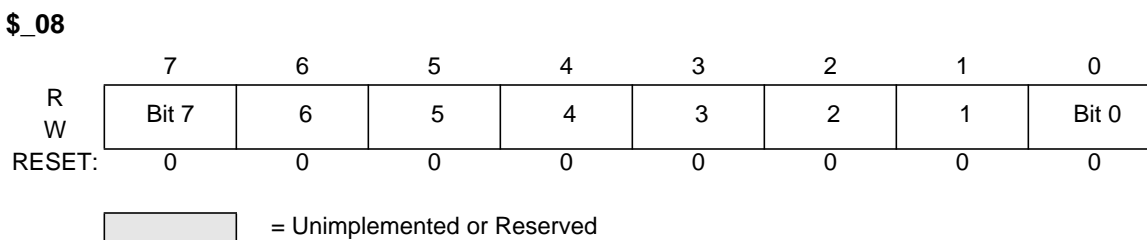

Figure 3-9 PWM Scale A Register (PWMSCLA)

Read: anytime

Write: anytime (causes the scale counter to load the PWMSCLA value)

3.3.10 PWM Scale B Register (PWMSCLB)

PWMSCLB is the programmable scale value used in scaling clock B to generate clock SB. Clock SB is generated by taking clock B, dividing it by the value in the PWMSCLB register and dividing that by two.

$$\text{Clock SB} = \text{Clock B} / (2 * \text{PWMSCLB})$$

NOTE: When PWMSCLB = \$00, PWMSCLB value is considered a full scale value of 256. Clock B is thus divided by 512.

Any value written to this register will cause the scale counter to load the new scale value (PWMSCLB).

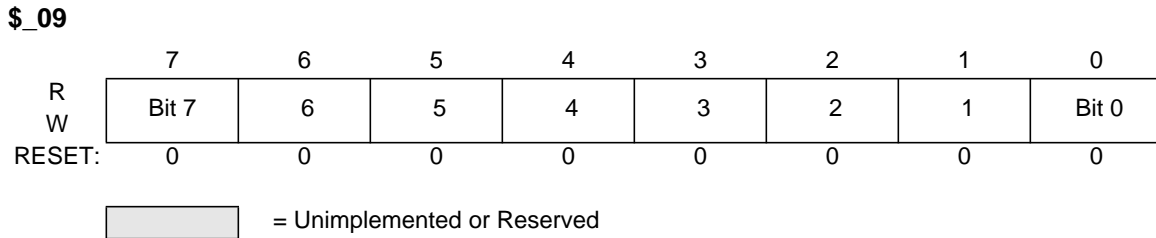

Figure 3-10 PWM Scale B Register (PWMSCLB)

Read: anytime

Write: anytime (causes the scale counter to load the PWMSCLB value).

3.3.11 Reserved Registers (PWMSCNTx)

The registers PWMSCNTA and PWMSCNTB are reserved for factory testing of the PWM module and are not available in normal modes.

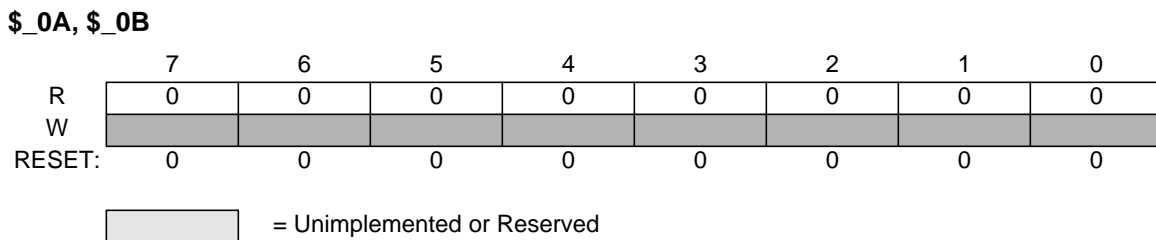

Figure 3-11 Reserved Registers (PWMSCNTx)

Read: always read \$00 in normal modes

Write: unimplemented in normal modes

NOTE: Writing to these registers when in special modes can alter the PWM functionality.

3.3.12 PWM Channel Counter Registers (PWMCNTx)

Each channel has a dedicated 8-bit up/down counter which runs at the rate of the selected clock source. The counter can be read at any time without affecting the count or the operation of the PWM channel. In left aligned output mode, the counter counts from 0 to the value in the period register - 1. In center aligned output mode, the counter counts from 0 up to the value in the period register and then back down to 0.

Any value written to the counter causes the counter to reset to \$00, the counter direction to be set to up, the immediate load of both duty and period registers with values from the buffers, and the output to change according to the polarity bit. The counter is also cleared at the end of the effective period (see Sections 4.2.5 Left Aligned Outputs and 4.2.6 Center Aligned Outputs for more details). When the channel is disabled (PWME_x=0), the PWMCNT_x register does not count. When a channel becomes enabled

(PWME_x=1), the associated PWM counter starts at the count in the PWMCNT_x register. For more detailed information on the operation of the counters, reference **4.2.4 PWM Timer Counters**.

In concatenated mode, writes to the 16-bit counter by using a 16-bit access or writes to either the low or high order byte of the counter will reset the 16-bit counter. Reads of the 16-bit counter must be made by 16-bit access to maintain data coherency.

NOTE: Writing to the counter while the channel is enabled can cause an irregular PWM cycle to occur.

\$_0C = PWMCNT0
\$_0D = PWMCNT1
\$_0E = PWMCNT2
\$_0F = PWMCNT3
\$_10 = PWMCNT4
\$_11 = PWMCNT5
\$_12 = PWMCNT6
\$_13 = PWMCNT7

	7	6	5	4	3	2	1	0
R	Bit 7	6	5	4	3	2	1	Bit 0
W	0	0	0	0	0	0	0	0
RESET:	0	0	0	0	0	0	0	0

 = Unimplemented or Reserved

Figure 3-12 PWM Channel Counter Registers (PWMCNT_x)

Read: anytime

Write: anytime (any value written causes PWM counter to be reset to \$00).

3.3.13 PWM Channel Period Registers (PWMPER_x)

There is a dedicated period register for each channel. The value in this register determines the period of the associated PWM channel.

The period registers for each channel are double buffered so that if they change while the channel is enabled, the change will NOT take effect until one of the following occurs:

- The effective period ends
- The counter is written (counter resets to \$00)
- The channel is disabled

In this way, the output of the PWM will always be either the old waveform or the new waveform, not some variation in between. If the channel is not enabled, then writes to the period register will go directly to the latches as well as the buffer.

NOTE: Reads of this register return the most recent value written. Reads do not necessarily return the value of the currently active period due to the double buffering scheme.

Reference **4.2.3 PWM Period and Duty** for more information.

To calculate the output period, take the selected clock source period for the channel of interest (A, B, SA, or SB) and multiply it by the value in the period register for that channel:

- Left Aligned Output (CAEx=0)
- $PWM_x \text{ Period} = \text{Channel Clock Period} * PWM_{PERx} \text{ Center Aligned Output (CAEx=1)}$
 $PWM_x \text{ Period} = \text{Channel Clock Period} * (2 * PWM_{PERx})$

For Boundary Case programming values, please refer to Section **4.2.8 PWM Boundary Cases**

- $\$_{14} = PWM_{PER0}$
- $\$_{15} = PWM_{PER1}$
- $\$_{16} = PWM_{PER2}$
- $\$_{17} = PWM_{PER3}$
- $\$_{18} = PWM_{PER4}$
- $\$_{19} = PWM_{PER5}$
- $\$_{1A} = PWM_{PER6}$
- $\$_{1B} = PWM_{PER7}$

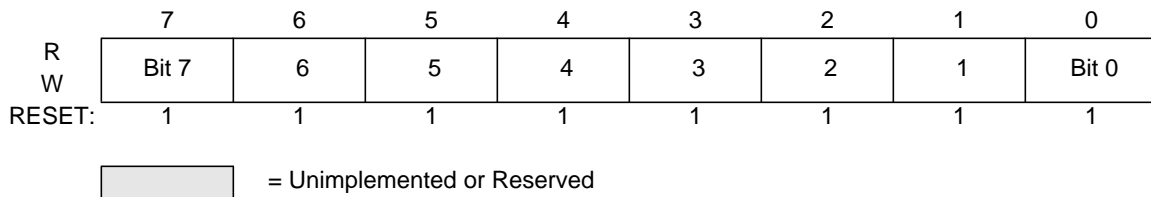

Figure 3-13 PWM Channel Period Registers (PWM_{PERx})

Read: anytime

Write: anytime

3.3.14 PWM Channel Duty Registers (PWMDTY_x)

There is a dedicated duty register for each channel. The value in this register determines the duty of the associated PWM channel. The duty value is compared to the counter and if it is equal to the counter value a match occurs and the output changes state.

The duty registers for each channel are double buffered so that if they change while the channel is enabled, the change will NOT take effect until one of the following occurs:

- The effective period ends
- The counter is written (counter resets to \$00)
- The channel is disabled

In this way, the output of the PWM will always be either the old duty waveform or the new duty waveform, not some variation in between. If the channel is not enabled, then writes to the duty register will go directly to the latches as well as the buffer.

NOTE: Reads of this register return the most recent value written. Reads do not necessarily return the value of the currently active duty due to the double buffering scheme.

Reference **4.2.3 PWM Period and Duty** for more information.

NOTE: Depending on the polarity bit, the duty registers will contain the count of either the high time or the low time. If the polarity bit is one, the output starts high and then goes low when the duty count is reached, so the duty registers contain a count of the high time. If the polarity bit is zero, the output starts low and then goes high when the duty count is reached, so the duty registers contain a count of the low time.

To calculate the output duty cycle (high time as a% of period) for a particular channel:

- Polarity = 0 (PPOLx=0)
Duty Cycle = $[(PWMPER_x - PWMDTY_x) / PWMPER_x] * 100\%$
- Polarity = 1 (PPOLx=1)
Duty Cycle = $[PWMDTY_x / PWMPER_x] * 100\%$
- For Boundary Case programming values, please refer to Section **4.2.8 PWM Boundary Cases**.

\$_1C = PWMDTY0
\$_1D = PWMDTY1
\$_1E = PWMDTY2
\$_1F = PWMDTY3
\$_20 = PWMDTY4
\$_21 = PWMDTY5
\$_22 = PWMDTY6
\$_23 = PWMDTY7

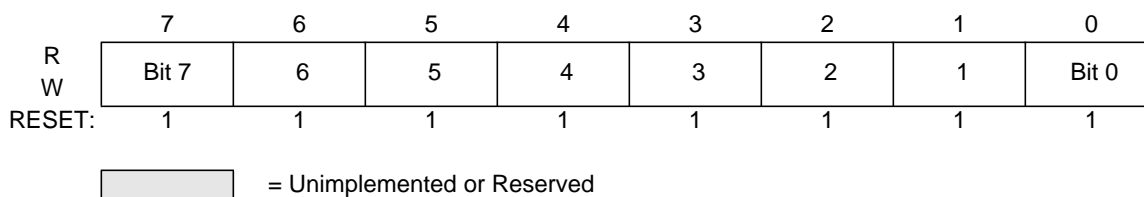

Figure 3-14 PWM Channel Duty Registers (PWMDTYx)

Read: anytime

Write: anytime

3.3.15 PWM Shutdown Register (PWMSDN)

The PWMSDN register provides for the shutdown functionality of the PWM module in the emergency cases. For proper operation channel 7 must be driven to the active level for a minimum of two bus clocks.



Figure 3-15 PWM Shutdown Register (PWMSDN)

Read: anytime

Write: anytime

PWM7ENA — PWM emergency shutdown Enable

If this bit is logic 1 the pin associated with channel 7 is forced to input and the emergency shutdown feature is enabled. All the other bits in this register are meaningful only if PWM7ENA = 1.

- 1 = PWM emergency feature is enabled.
- 0 = PWM emergency feature disabled.

PWM7INL — PWM shutdown active input level for channel 7.

If the emergency shutdown feature is enabled (PWM7ENA = 1), this bit determines the active level of the PWM7channel.

- 1 = Active level is high
- 0 = Active level is low

PWM7IN — PWM channel 7 input status.

This reflects the current status of the PWM7 pin.

PWMLVL — PWM shutdown output Level.

If active level as defined by the PWM7IN input, gets asserted all enabled PWM channels are immediately driven to the level defined by PWMLVL.

- 1 = PWM outputs are forced to 1.
- 0 = PWM outputs are forced to 0

PWMRSTRT — PWM Restart.

The PWM can only be restarted if the PWM channel input 7 is de-asserted. After writing a logic 1 to the PWMRSTRT bit (trigger event) the PWM channels start running after the corresponding counter passes next “counter == 0” phase.

Also if the PWM7ENA bit is reset to 0, the PWM do not start before the counter passes \$00.
The bit is always read as “0”.

PWMIE — PWM Interrupt Enable

If interrupt is enabled an interrupt to the CPU is asserted.

- 1 = PWM interrupt is enabled.
- 0 = PWM interrupt is disabled.

PWMIF — PWM Interrupt Flag

Any change from passive to asserted (active) state or from active to passive state will be flagged by setting the PWMIF flag = 1. The flag is cleared by writing a logic 1 to it. Writing a 0 has no effect.

- 1 = change on PWM7IN input
- 0 = No change on PWM7IN input.

Section 4 Functional Description

4.1 PWM Clock Select

There are four available clocks called clock A, clock B, clock SA (Scaled A), and clock SB (Scaled B). These four clocks are based on the bus clock.

Clock A and B can be software selected to be 1, 1/2, 1/4, 1/8,..., 1/64, 1/128 times the bus clock. Clock SA uses clock A as an input and divides it further with a reloadable counter. Similarly, Clock SB uses clock B as an input and divides it further with a reloadable counter. The rates available for clock SA are software selectable to be clock A divided by 2, 4, 6, 8,..., or 512 in increments of divide by 2. Similar rates are available for clock SB. Each PWM channel has the capability of selecting one of two clocks, either the pre-scaled clock (clock A or B) or the scaled clock (clock SA or SB).

The block diagram in **Figure 4-1** shows the four different clocks and how the scaled clocks are created.

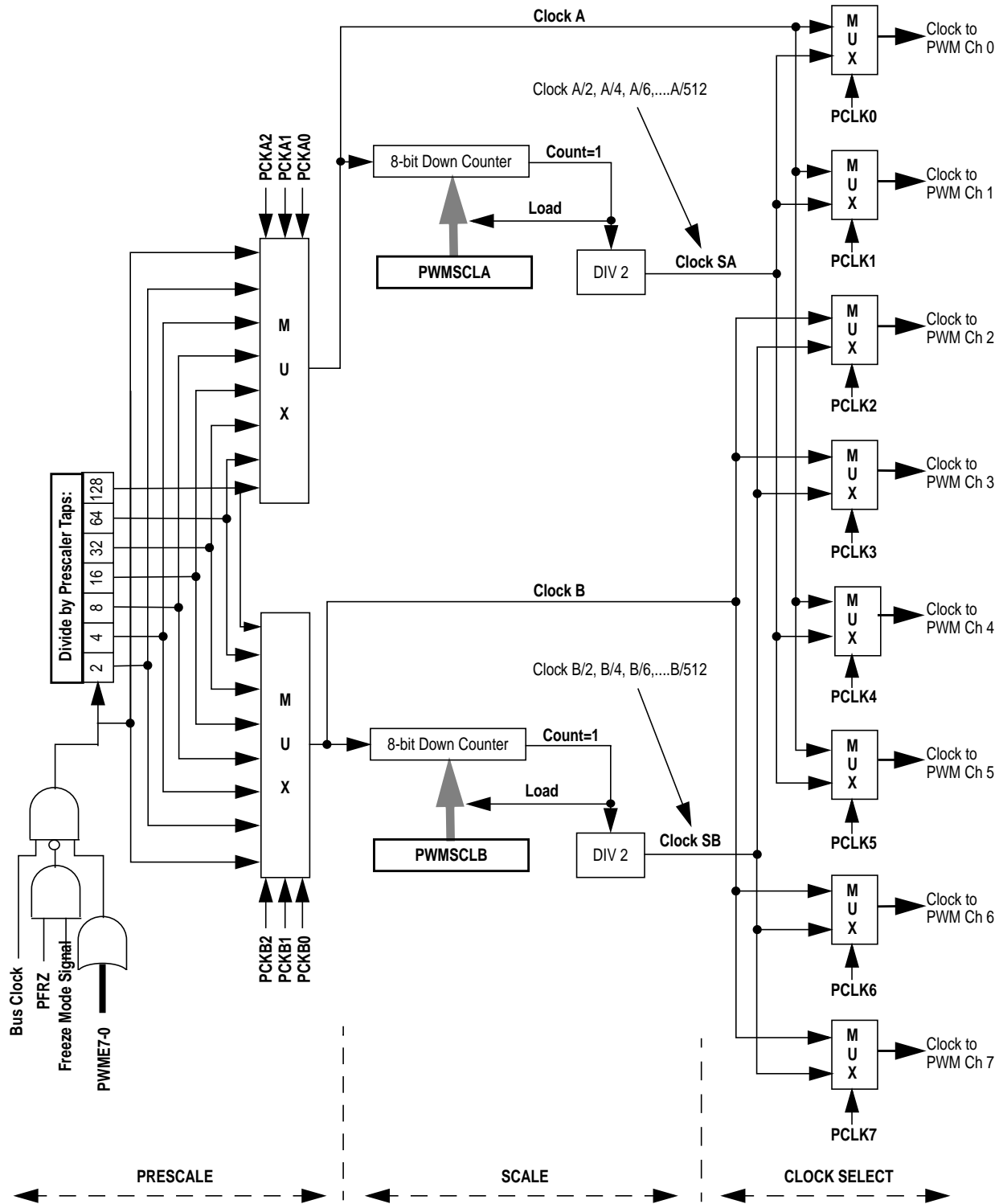

Figure 4-1 PWM Clock Select Block Diagram

4.1.1 Prescale

The input clock to the PWM prescaler is the bus clock. It can be disabled whenever the part is in freeze mode by setting the PFRZ bit in the PWMCTL register. If this bit is set, whenever the MCU is in freeze mode (Freeze Mode Signal active) the input clock to the prescaler is disabled. This is useful for emulation in order to freeze the PWM. The input clock can also be disabled when all eight PWM channels are disabled (PWME7-0=0). This is useful for reducing power by disabling the prescale counter.

Clock A and clock B are scaled values of the input clock. The value is software selectable for both clock A and clock B and has options of 1, 1/2, 1/4, 1/8, 1/16, 1/32, 1/64, or 1/128 times the bus clock. The value selected for clock A is determined by the PCKA2, PCKA1, PCKA0 bits in the PWMPRCLK register. The value selected for clock B is determined by the PCKB2, PCKB1, PCKB0 bits also in the PWMPRCLK register.

4.1.2 Clock Scale

The scaled A clock uses clock A as an input and divides it further with a user programmable value and then divides this by 2. The scaled B clock uses clock B as an input and divides it further with a user programmable value and then divides this by 2. The rates available for clock SA are software selectable to be clock A divided by 2, 4, 6, 8,..., or 512 in increments of divide by 2. Similar rates are available for clock SB.

Clock A is used as an input to an 8-bit down counter. This down counter loads a user programmable scale value from the scale register (PWMSCLA). When the down counter reaches one, two things happen; a pulse is output and the 8-bit counter is re-loaded. The output signal from this circuit is further divided by two. This gives a greater range with only a slight reduction in granularity. Clock SA equals Clock A divided by two times the value in the PWMSCLA register.

NOTE: $\text{Clock SA} = \text{Clock A} / (2 * \text{PWMSCLA})$

*When PWMSCLA = \$00, PWMSCLA value is considered a full scale value of 256.
Clock A is thus divided by 512.*

Similarly, Clock B is used as an input to an 8-bit down counter followed by a divide by two producing clock SB. Thus, clock SB equals Clock B divided by two times the value in the PWMSCLB register.

NOTE: $\text{Clock SB} = \text{Clock B} / (2 * \text{PWMSCLB})$

*When PWMSCLB = \$00, PWMSCLB value is considered a full scale value of 256.
Clock B is thus divided by 512.*

As an example, consider the case in which the user writes \$FF into the PWMSCLA register. Clock A for this case will be E divided by 4. A pulse will occur at a rate of once every 255x4 E cycles. Passing this through the divide by two circuit produces a clock signal at an E divided by 2040 rate. Similarly, a value of \$01 in the PWMSCLA register when clock A is E divided by 4 will produce a clock at an E divided by 8 rate.

Writing to PWMSCLA or PWMSCLB causes the associated 8-bit down counter to be re-loaded. Otherwise, when changing rates the counter would have to count down to \$01 before counting at the proper rate. Forcing the associated counter to re-load the scale register value every time PWMSCLA or PWMSCLB is written prevents this.

NOTE: *Writing to the scale registers while channels are operating can cause irregularities in the PWM outputs.*

4.1.3 Clock Select

Each PWM channel has the capability of selecting one of two clocks. For channels 0, 1, 4, and 5 the clock choices are clock A or clock SA. For channels 2, 3, 6, and 7 the choices are clock B or clock SB. The clock selection is done with the PCLKx control bits in the PWMCLK register.

NOTE: *Changing clock control bits while channels are operating can cause irregularities in the PWM outputs.*

4.2 PWM Channel Timers

The main part of the PWM module are the actual timers. Each of the timer channels has a counter, a period register and a duty register (each are 8-bit). The waveform output period is controlled by a match between the period register and the value in the counter. The duty is controlled by a match between the duty register and the counter value and causes the state of the output to change during the period. The starting polarity of the output is also selectable on a per channel basis. Shown below in **Figure 4-2** is the block diagram for the PWM timer.

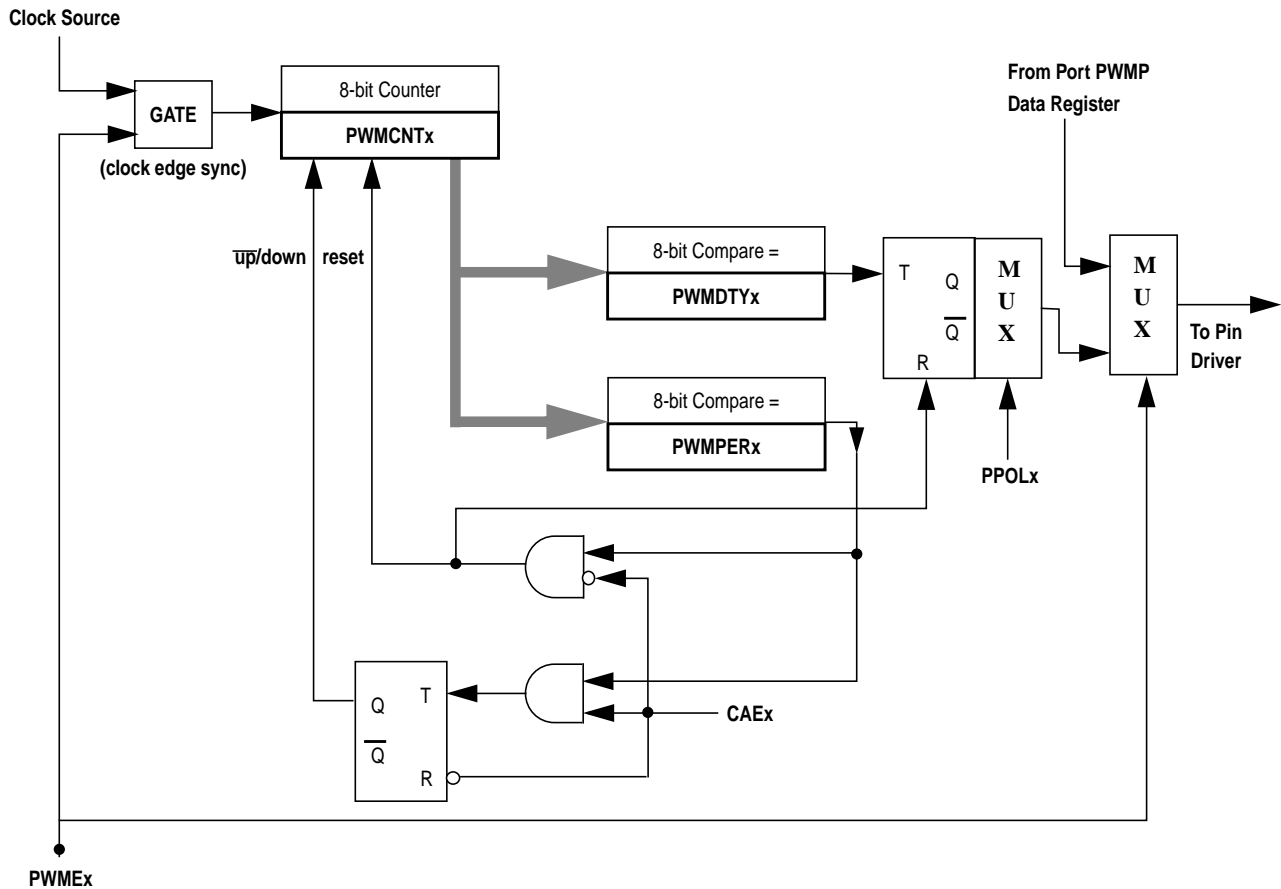

Figure 4-2 PWM Timer Channel Block Diagram

4.2.1 PWM Enable

Each PWM channel has an enable bit (PWME_x) to start its waveform output. When any of the PWME_x bits are set (PWME_x=1), the associated PWM output signal is enabled immediately. However, the actual PWM waveform is not available on the associated PWM output until its clock source begins its next cycle due to the synchronization of PWME_x and the clock source. An exception to this is when channels are concatenated. Refer to **Section 4.2.7 PWM 16-Bit Functions** for more detail.

NOTE: The first PWM cycle after enabling the channel can be irregular.

On the front end of the PWM timer, the clock is enabled to the PWM circuit by the PWME_x bit being high. There is an edge-synchronizing circuit to guarantee that the clock will only be enabled or disabled at an edge. When the channel is disabled (PWME_x=0), the counter for the channel does not count.

4.2.2 PWM Polarity

Each channel has a polarity bit to allow starting a waveform cycle with a high or low signal. This is shown on the block diagram as a Mux select of either the Q output or the \bar{Q} output of the PWM output flip flop.

When one of the bits in the PWMPOL register is set, the associated PWM channel output is high at the beginning of the waveform, then goes low when the duty count is reached. Conversely, if the polarity bit is zero, the output starts low and then goes high when the duty count is reached.

4.2.3 PWM Period and Duty

Dedicated period and duty registers exist for each channel and are double buffered so that if they change while the channel is enabled, the change will NOT take effect until one of the following occurs:

- The effective period ends
- The counter is written (counter resets to \$00)
- The channel is disabled

In this way, the output of the PWM will always be either the old waveform or the new waveform, not some variation in between. If the channel is not enabled, then writes to the period and duty registers will go directly to the latches as well as the buffer.

A change in duty or period can be forced into effect “immediately” by writing the new value to the duty and/or period registers and then writing to the counter. This forces the counter to reset and the new duty and/or period values to be latched. In addition, since the counter is readable it is possible to know where the count is with respect to the duty value and software can be used to make adjustments

NOTE: *When forcing a new period or duty into effect immediately, an irregular PWM cycle can occur.*

NOTE: *Depending on the polarity bit, the duty registers will contain the count of either the high time or the low time.*

4.2.4 PWM Timer Counters

Each channel has a dedicated 8-bit up/down counter which runs at the rate of the selected clock source (reference **Section 4.1 PWM Clock Select** for the available clock sources and rates). The counter compares to two registers, a duty register and a period register as shown in **Figure 4-2 PWM Timer Channel Block Diagram**. When the PWM counter matches the duty register the output flip-flop changes state causing the PWM waveform to also change state. A match between the PWM counter and the period register behaves differently depending on what output mode is selected as shown in **Figure 4-2 PWM Timer Channel Block Diagram** and described in **Section 4.2.5 Left Aligned Outputs** and **Section 4.2.6 Center Aligned Outputs**.

Each channel counter can be read at anytime without affecting the count or the operation of the PWM channel.

Any value written to the counter causes the counter to reset to \$00, the counter direction to be set to up, the immediate load of both duty and period registers with values from the buffers, and the output to change according to the polarity bit. When the channel is disabled (PWME_x=0), the counter stops. When a channel becomes enabled (PWME_x=1), the associated PWM counter continues from the count in the PWMCNT_x register. This allows the waveform to continue where it left off when the channel is

re-enabled. When the channel is disabled, writing “0” to the period register will cause the counter to reset on the next selected clock.

NOTE: *If the user wants to start a new “clean” PWM waveform without any “history” from the old waveform, the user must write to channel counter (PWMCNTx) prior to enabling the PWM channel (PWMEx=1).*

Generally, writes to the counter are done prior to enabling a channel in order to start from a known state. However, writing a counter can also be done while the PWM channel is enabled (counting). The effect is similar to writing the counter when the channel is disabled except that the new period is started immediately with the output set according to the polarity bit.

NOTE: *Writing to the counter while the channel is enabled can cause an irregular PWM cycle to occur.*

The counter is cleared at the end of the effective period (see **Section 4.2.5 Left Aligned Outputs** and **Section 4.2.6 Center Aligned Outputs** for more details).

Table 4-1 PWM Timer Counter Conditions

Counter Clears (\$00)	Counter Counts	Counter Stops
When PWMCNTx register written to any value	When PWM channel is enabled (PWMEx=1). Counts from last value in PWMCNTx.	When PWM channel is disabled (PWMEx=0)
Effective period ends		

4.2.5 Left Aligned Outputs

The PWM timer provides the choice of two types of outputs, Left Aligned or Center Aligned outputs. They are selected with the CAEx bits in the PWMCAE register. If the CAEx bit is cleared (CAEx=0), the corresponding PWM output will be left aligned.

In left aligned output mode, the 8-bit counter is configured as an up counter only. It compares to two registers, a duty register and a period register as shown in the block diagram in **Figure 4-2 PWM Timer Channel Block Diagram**. When the PWM counter matches the duty register the output flip-flop changes state causing the PWM waveform to also change state. A match between the PWM counter and the period register resets the counter and the output flip-flop as shown in **Figure 4-2 PWM Timer Channel Block Diagram** as well as performing a load from the double buffer period and duty register to the associated registers as described in **Section 4.2.3 PWM Period and Duty**. The counter counts from 0 to the value in the period register - 1.

NOTE: *Changing the PWM output mode from Left Aligned Output to Center Aligned Output (or vice versa) while channels are operating can cause irregularities in the PWM output. It is recommended to program the output mode before enabling the PWM channel.*

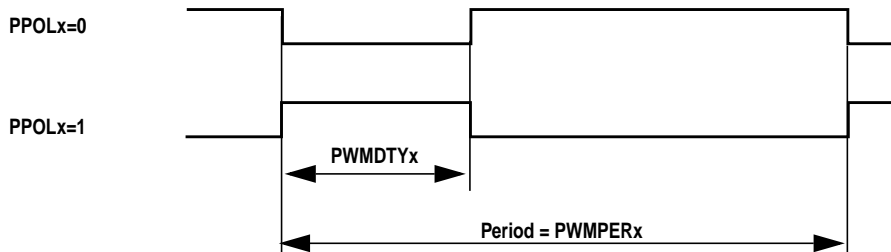

Figure 4-3 PWM Left Aligned Output Waveform

To calculate the output frequency in left aligned output mode for a particular channel, take the selected clock source frequency for the channel (A, B, SA, or SB) and divide it by the value in the period register for that channel.

- PWMx Frequency = Clock(A, B, SA, or SB) / PWMPER_x
- PWMx Duty Cycle (high time as a% of period):
 - Polarity = 0 (PPOL_x=0)
Duty Cycle = [(PWMPER_x-PWMDTY_x)/PWMPER_x] * 100%
 - Polarity = 1 (PPOL_x=1)
Duty Cycle = [PWMDTY_x / PWMPER_x] * 100%

As an example of a left aligned output, consider the following case:

Clock Source = E, where E=10MHz (100ns period)

PPOL_x = 0

PWMPER_x = 4

PWMDTY_x = 1

PWMx Frequency = 10MHz/4 = 2.5MHz

PWMx Period = 400ns

PWMx Duty Cycle = 3/4 *100% = 75%

Shown below is the output waveform generated.

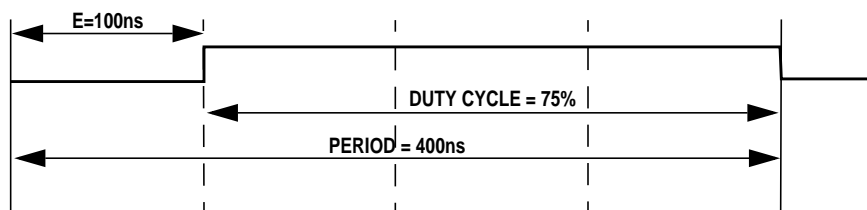

Figure 4-4 PWM Left Aligned Output Example Waveform

4.2.6 Center Aligned Outputs

For Center Aligned Output Mode selection, set the CAEx bit (CAEx=1) in the PWMCAE register and the corresponding PWM output will be center aligned.

The 8-bit counter operates as an up/down counter in this mode and is set to up whenever the counter is equal to \$00. The counter compares to two registers, a duty register and a period register as shown in the block diagram in **Figure 4-2 PWM Timer Channel Block Diagram**. When the PWM counter matches the duty register the output flip-flop changes state causing the PWM waveform to also change state. A match between the PWM counter and the period register changes the counter direction from an up-count to a down-count. When the PWM counter decrements and matches the duty register again, the output flip-flop changes state causing the PWM output to also change state. When the PWM counter decrements and reaches zero, the counter direction changes from a down-count back to an up-count and a load from the double buffer period and duty registers to the associated registers is performed as described in **Section 4.2.3 PWM Period and Duty**. The counter counts from 0 up to the value in the period register and then back down to 0. Thus the effective period is $PWMPERx*2$.

NOTE: Changing the PWM output mode from Left Aligned Output to Center Aligned Output (or vice versa) while channels are operating can cause irregularities in the PWM output. It is recommended to program the output mode before enabling the PWM channel.

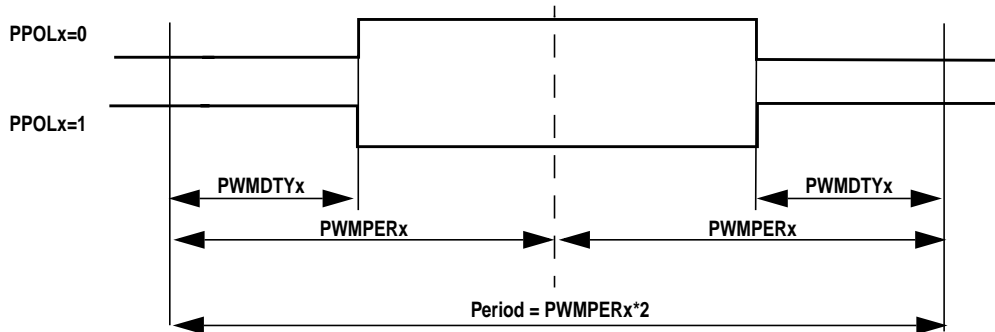

Figure 4-5 PWM Center Aligned Output Waveform

To calculate the output frequency in center aligned output mode for a particular channel, take the selected clock source frequency for the channel (A, B, SA, or SB) and divide it by twice the value in the period register for that channel.

- $PWMx \text{ Frequency} = \text{Clock}(A, B, SA, \text{ or } SB) / (2 * PWMPERx)$
- PWMx Duty Cycle (high time as a% of period):
 - Polarity = 0 (PPOLx=0)
 $\text{Duty Cycle} = [(PWMPERx - PWMDTYx) / PWMPERx] * 100\%$
 - Polarity = 1 (PPOLx=1)

$$\text{Duty Cycle} = [\text{PWMDTY}_x / \text{PWMPER}_x] * 100\%$$

As an example of a center aligned output, consider the following case:

Clock Source = E, where E=10MHz (100ns period)

PPOL_x = 0

PWMPER_x = 4

PWMDTY_x = 1

PWM_x Frequency = 10MHz/8 = 1.25MHz

PWM_x Period = 800ns

PWM_x Duty Cycle = 3/4 * 100% = 75%

Shown below is the output waveform generated.

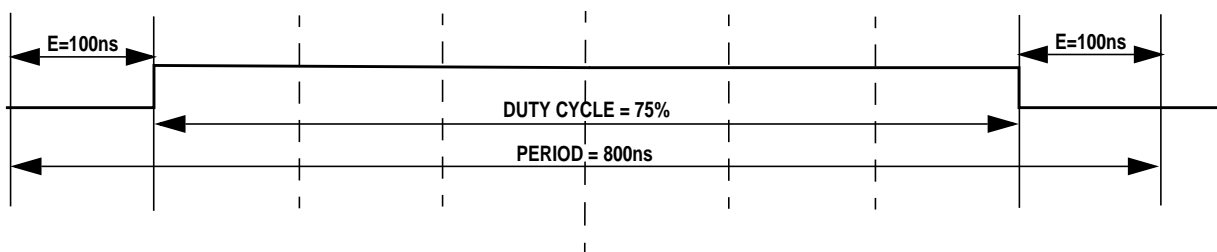

Figure 4-6 PWM Center Aligned Output Example Waveform

4.2.7 PWM 16-Bit Functions

The PWM timer also has the option of generating 8-channels of 8-bits or 4-channels of 16-bits for greater PWM resolution. This 16-bit channel option is achieved through the concatenation of two 8-bit channels.

The PWMCTL register contains four control bits, each of which is used to concatenate a pair of PWM channels into one 16-bit channel. Channels 6 and 7 are concatenated with the CON67 bit, channels 4 and 5 are concatenated with the CON45 bit, channels 2 and 3 are concatenated with the CON23 bit, and channels 0 and 1 are concatenated with the CON01 bit.

NOTE: *Change these bits only when both corresponding channels are disabled.*

When channels 6 and 7 are concatenated, channel 6 registers become the high order bytes of the double byte channel as shown in **Figure 4-7 PWM 16-Bit Mode**. Similarly, when channels 4 and 5 are concatenated, channel 4 registers become the high order bytes of the double byte channel. When channels 2 and 3 are concatenated, channel 2 registers become the high order bytes of the double byte channel. When channels 0 and 1 are concatenated, channel 0 registers become the high order bytes of the double

byte channel.

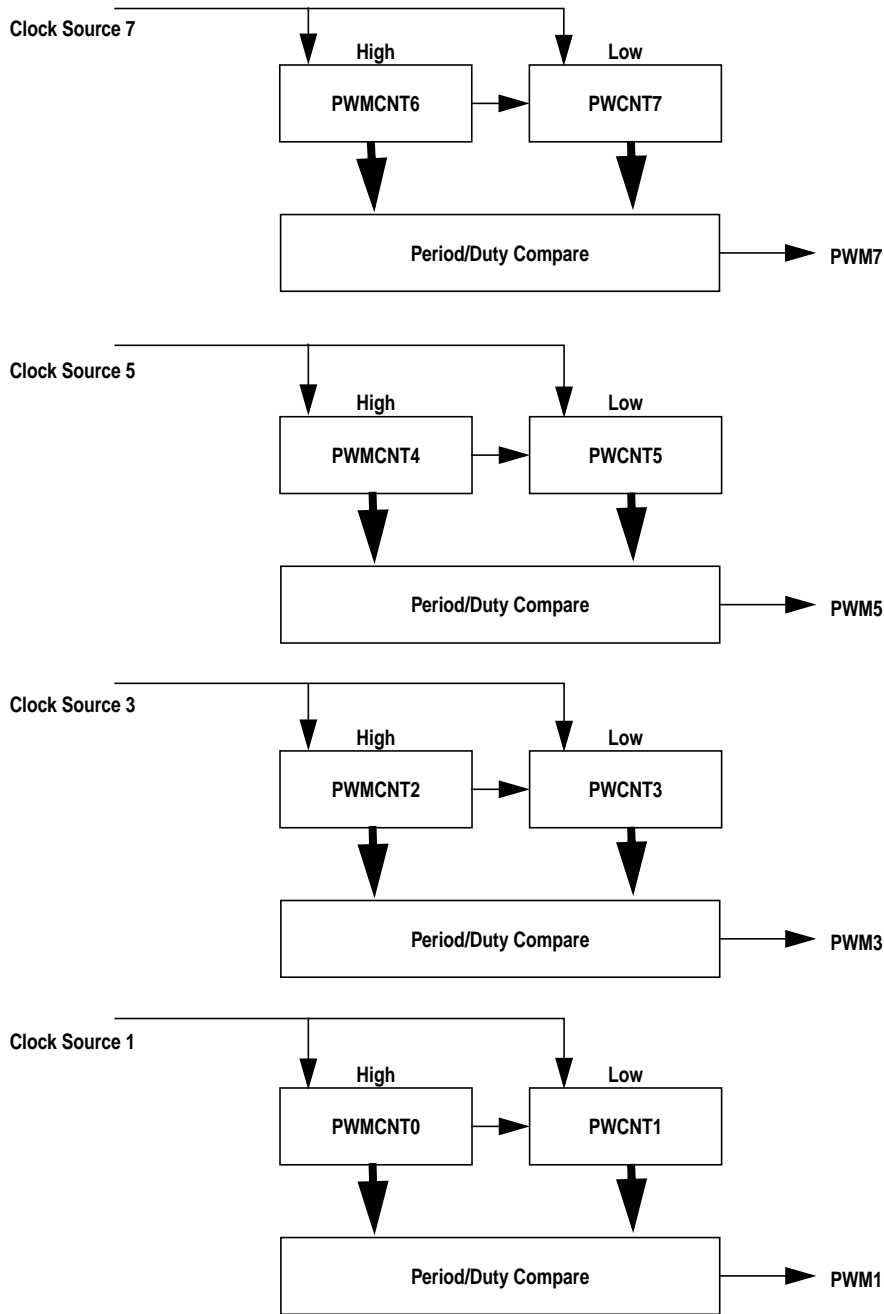

Figure 4-7 PWM 16-Bit Mode

When using the 16-bit concatenated mode, the clock source is determined by the low order 8-bit channel clock select control bits. That is channel 7 when channels 6 and 7 are concatenated, channel 5 when channels 4 and 5 are concatenated, channel 3 when channels 2 and 3 are concatenated, and channel 1 when channels 0 and 1 are concatenated. The resulting PWM is output to the pins of the corresponding low order

8-bit channel as also shown in **Figure 4-7 PWM 16-Bit Mode**. The polarity of the resulting PWM output is controlled by the PPOLx bit of the corresponding low order 8-bit channel as well.

Once concatenated mode is enabled (CONxx bits set in PWMCTL register) then enabling/disabling the corresponding 16-bit PWM channel is controlled by the low order PWMEx bit. In this case, the high order bytes PWMEx bits have no effect and their corresponding PWM output is disabled.

In concatenated mode, writes to the 16-bit counter by using a 16-bit access or writes to either the low or high order byte of the counter will reset the 16-bit counter. Reads of the 16-bit counter must be made by 16-bit access to maintain data coherency.

Either left aligned or center aligned output mode can be used in concatenated mode and is controlled by the low order CAEx bit. The high order CAEx bit has no effect.

The table shown below is used to summarize which channels are used to set the various control bits when in 16-bit mode.

Table 4-2 16-bit Concatenation Mode Summary

CONxx	PWMEx	PPOLx	PCLKx	CAEx	PWMx OUTPUT
CON67	PWME7	PPOL7	PCLK7	CAE7	PWM7
CON45	PWME5	PPOL5	PCLK5	CAE5	PWM5
CON23	PWME3	PPOL3	PCLK3	CAE3	PWM3
CON01	PWME1	PPOL1	PCLK1	CAE1	PWM1

4.2.8 PWM Boundary Cases

The following table summarizes the boundary conditions for the PWM regardless of the output mode (Left Aligned or Center Aligned) and 8-bit (normal) or 16-bit (concatenation).

Table 4-3 PWM Boundary Cases

PWMDTYx	PWMPERx	PPOLx	PWMx Output
\$00 (indicates no duty)	>\$00	1	Always Low
\$00 (indicates no duty)	>\$00	0	Always High
XX	\$00 ¹ (indicates no period)	1	Always High
XX	\$00 ¹ (indicates no period)	0	Always Low
>= PWMPERx	XX	1	Always High
>= PWMPERx	XX	0	Always Low

NOTES:

1. Counter=\$00 and does not count.

Section 5 Resets

5.1 General

The reset state of each individual bit is listed within the Register Description section **Section 3.3 Register Descriptions** which details the registers and their bit-fields. All special functions or modes which are initialized during or just following reset are described within this section.

- The 8-bit up/down counter is configured as an up counter out of reset.
- All the channels are disabled and all the counters don't count.

Section 6 Interrupts

6.1 Interrupt Operation

The PWM module has only one interrupt which is generated at the time of emergency shutdown, if the corresponding enable bit (PWMIE) is set. This bit is the enable for the interrupt. The interrupt flag PWMIF is set whenever the input level of the PWM7 channel changes while PWM7ENA=1 or when PWMENA is being asserted while the level at PWM7 is active.

In STOP mode or WAIT mode (with the PSWAI bit set) the emergency shutdown feature will drive the PWM outputs to their shutdown output levels but the PWMIF flag will not be set.

A description of the registers involved and affected due to this interrupt is explained in **Section 3.3.15 PWM Shutdown Register (PWMSDN)**.

The PWM block only generates the interrupt and does not service it. The interrupt signal name is PWM Interrupt Signal.

User Guide End Sheet

Freescale Semiconductor, Inc.

**FINAL PAGE OF
54
PAGES**