

# HCI1

**MC68HC11D3**

**MC68HC711D3**

**PROGRAMMING  
REFERENCE  
GUIDE**

Freescale Semiconductor, Inc.



**MOTOROLA**

For More Information On This Product,  
Go to: [www.freescale.com](http://www.freescale.com)

# Freescale Semiconductor, Inc. BLOCK DIAGRAM

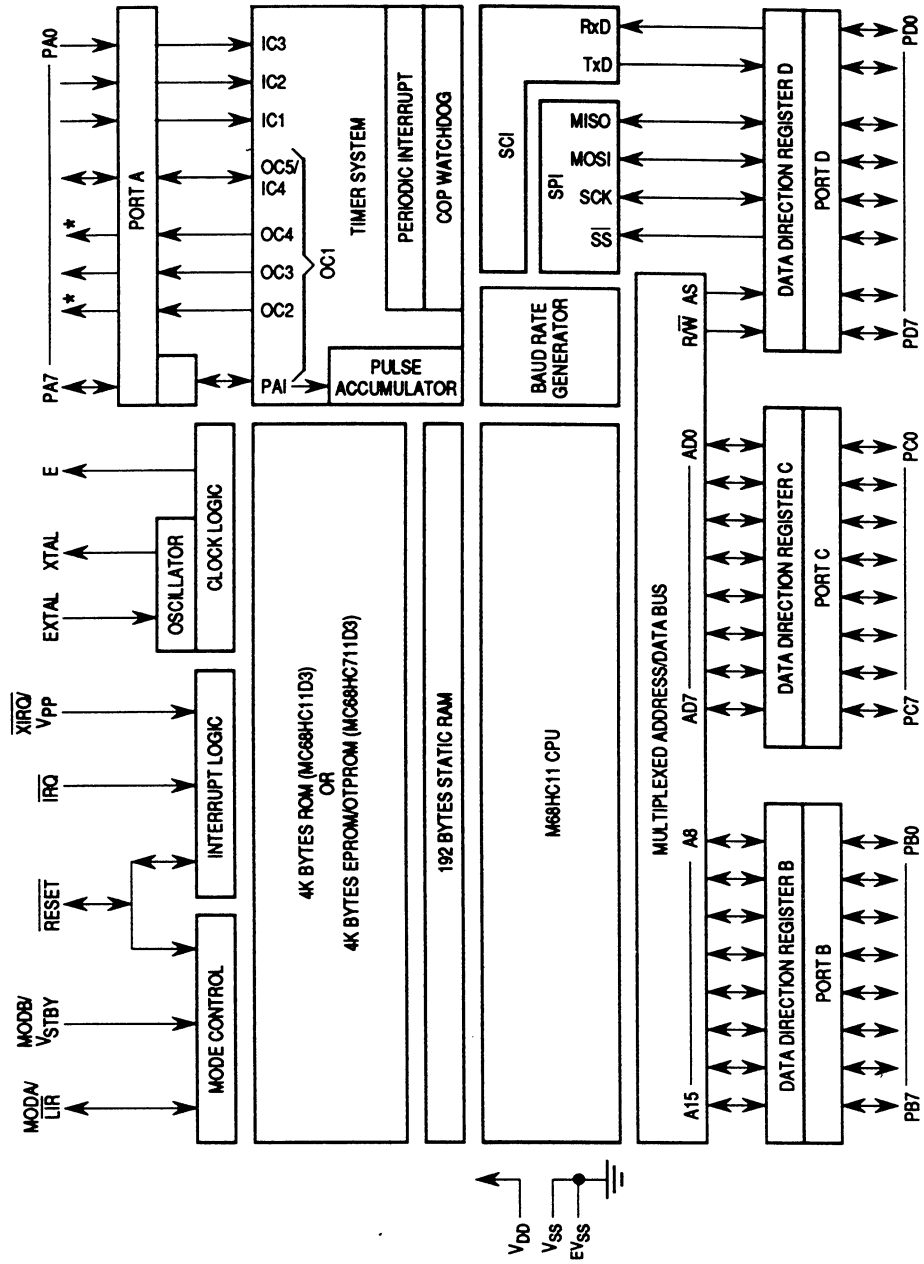

\* PA6 and PA4 not bonded in 40 pin DIP

**PROGRAMMING MODEL  
CRYSTAL DEPENDENT TIMING  
INTERRUPTS**

**MEMORY MAP  
OPCODE MAPS**

**INSTRUCTIONS  
ADDRESSING MODES  
EXECUTION TIMES  
SPECIAL OPERATIONS**

**REGISTER AND  
CONTROL BIT  
ASSIGNMENTS**

**MECHANICAL DATA  
HEX/DEC CONVERSION  
ASCII CHART**

**© MOTOROLA, INC 1991**



**PROGRAMMING MODEL  
CRYSTAL DEPENDENT TIMING  
INTERRUPTS**



**MEMORY MAP  
OPCODE MAPS**



**INSTRUCTIONS  
ADDRESSING MODES  
EXECUTION TIMES  
SPECIAL OPERATIONS**



**REGISTER AND  
CONTROL BIT  
ASSIGNMENTS**



**MECHANICAL DATA  
HEX/DEC CONVERSION  
ASCII CHART**

## PROGRAMMING MODEL

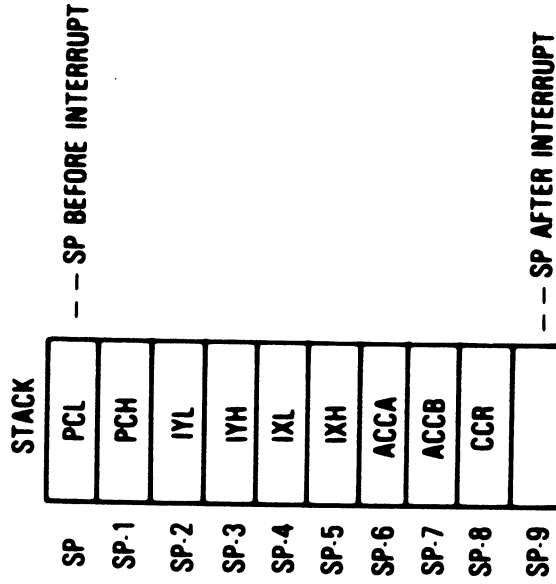
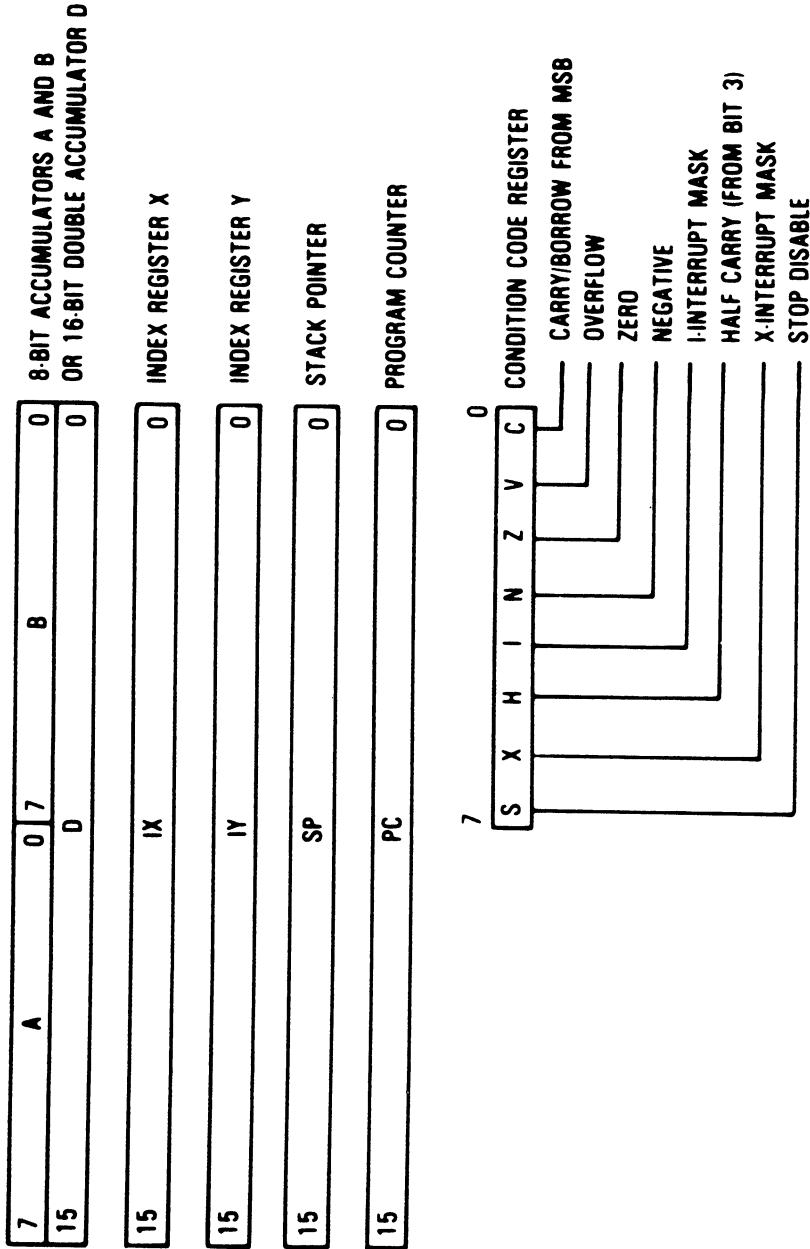



**CRYSTAL DEPENDENT TIMING SUMMARY**

	Selected Crystal	Common Xtal Frequencies (others could be used)			
		22.3 Hz 8.389 MHz	8.0 MHz	4.0 MHz	
<b>CPU Clock</b>	(E)	2.1 MHz	2.0 MHz	1.0 MHz	
<b>Cycle Time</b>	(1/E)	477 ns	500 ns	1000 ns	
<b>Periodic (RTI) Interrupt Rates</b>	RTR_	1	0		
(E/2 <sup>13</sup> )	0	0	0	0	8.19 ms
(E/2 <sup>14</sup> )	0	1	1	1	16.38 ms
(E/2 <sup>15</sup> )	1	0	0	0	32.77 ms
(E/2 <sup>16</sup> )	1	1	1	1	65.54 ms
<b>SPI Bit Rates (baud)</b>	SPR_	1	0		
(E/2)	0	0	0	0	500 K
(E/4)	0	1	1	1	250 K
(E/16)	1	0	0	0	62.5 K
(E/32)	1	1	1	1	31.25 K

SCI Baud Rates	Control Bits				Only the max and min baud rates are shown in this table (SCR2=0 = 000 or 111). Additional rates are simple multiples of 2 from min to max.		
	SCP_	2	SCR_	0			
(E/1) (pre out/16) (pre out/2048)	1 0	2 1	SCR_ 0	0	custom 131.07 K 1024	— 124.80 K 976.6	— 62.40 K 488.3
(E/3) (pre out/16) (pre out/2048)	0 1	0 0	0 0	0 0	— 43.691 K 341.3	— 41.6 K 325.5	— 20.8 K 162.8
(E/4) (pre out/16) (pre out/2048)	1 0	0 0	0 0	0 0	custom 32.768 K 256	— 31.2 K 244.1	— 15.6 K 122.1
(E/13) (pre out/16) (pre out/2048)	1 1	0 1	0 0	0 0	— 10.082 K 78.77	common 9600 75	common 4800 37.56





	Selected Crystal	Common Xtal Frequencies (others could be used)		
		223 Hz 8.389 MHz	8.0 MHz	4.0 MHz
<b>CPU Clock</b>	(E)	2.1 MHz	2.0 MHz	1.0 MHz
<b>Cycle Time</b>	(1/E)	477 ns	500 ns	1000 ns
<b>COP Watchdog Timeout Rates</b>	CR_ 1 0			
(E/2 <sup>15</sup> )	0 0	15.625 ms	16.384 ms	32.768 ms
(E/2 <sup>17</sup> )	0 1	62.5 ms	65.536 ms	131.07 ms
(E/2 <sup>19</sup> )	1 0	250 ms	262.14 ms	524.29 ms
(E/2 <sup>21</sup> )	1 1	1 s	1.049 s	2.1 s
(E/2 <sup>15</sup> )	Timeout Tolerance (-0 ms/+ ...)	15.6 ms	16.4 ms	32.8 ms
<b>Pulse Accumulator (in gated mode)</b>				
(E/2 <sup>6</sup> )	1 count -	30.52 μs	32 μs	64 μs
(E/2 <sup>14</sup> )	overflow -	7.80 ms	8.19 ms	16.38 ms



Main Timer Count Rates	PR_	1	0			
(E/1) (E/2 <sup>16</sup> )	1 count – overflow –	0	0	477 ns 31.25 ms	500 ns 32.77 ms	1.0 μs 65.54 ms
(E/4) (E/2 <sup>18</sup> )	1 count – overflow –	0	1	1.91 μs 125 ms	2.0 μs 131.1 ms	4.0 μs 262.1 ms
(E/8) (E/2 <sup>19</sup> )	1 count – overflow –	1	0	3.81 μs 250 ms	4.0 μs 262.1 ms	8.0 μs 524.3 ms
(E/16) (E/2 <sup>20</sup> )	1 count – overflow –	1	1	7.63 μs 0.5 s	8.0 μs 524.3 ms	16.0 μs 1.049 s



## Interrupt Vector Assignments

Vector Address	Interrupt Source	CC Register Mask	Local Mask
FFC0, C1 • •	Reserved • •	—	—
FFD4, D5 FFD6, D7	Reserved SCI Serial System	— I Bit	— See Table
FFD8, D9 FFDA, DB FFDC, DD FFDE, DF	SPI Serial Transfer Complete Pulse Accumulator Input Edge Pulse Accumulator Overflow Timer Overflow	I Bit I Bit I Bit I Bit	SPIE PAII PAOVI TOI
FFE0, E1 FFE2, E3 FFE4, E5 FFE6, E7	Timer Input Capture 4/Output Compare 5 Timer Output Compare 4 Timer Output Compare 3 Timer Output Compare 2	I Bit I Bit I Bit I Bit	I4O5I OC4I OC3I OC2I
FFE8, E9 FFEA, EB FFEC, ED FFEE, EF	Timer Output Compare 1 Timer Input Capture 3 Timer Input Capture 2 Timer Input Capture 1	I Bit I Bit I Bit I Bit	OC1I IC3I IC2I IC1I
FFF0, F1 FFF2, F3	Real-Time Interrupt $\overline{IRQ}$ (External Pin)	I Bit I Bit	RTII None
<b>SEE HPRIO REGISTER FOR HIGHEST PRIORITY I-BIT SOURCE</b>			
FFF4, F5 FFF6, F7	$\overline{XIRQ}$ Pin (Pseudo Nonmaskable Interrupt) SWI	X Bit None	None None
FFF8, F9 FFFA, FB FFFC, FD FFFE, FF	Illegal Opcode Trap COP Failure (Reset) COP Clock Monitor Fail (Reset) $\overline{RESET}$	None None None None	None NOCOP CME None

LOWEST  
 ↑  
 RELATIVE PRIORITY  
 ↓  
 HIGHEST

## SCI Serial System Interrupts

Interrupt Cause	Local Mask
Receive Data Register Full	RIE
Receiver Overrun	RIE
Idle Line Detected	ILIE
Transmit Data Register Empty	TIE
Transmit Complete	TCIE

OPCODE MAP (PAGE 1)

MSB	0	1	2	3	4	5	6	7	8	ACCA			ACCB		
										INH	DIR	IND,X	EXT	IMM	DIR
0000	TEST	SBA	BRA	TSX	NEG			SUB			SUB				
0001	NOP	CBA	BRN	INS	NEG			CMP			CMP				
0010	IDIV	BRSET	BHI	PULA	COM			SUBD			SBC				
0011	FDIV	BRCLR	BLS	PULB	COM			AND			ADDD				
0100	LSRD	BSET	BCC	DES	LSR			AND			AND				
0101	ASLD	BCLR	BCS	TXS	ROR			BIT			BIT				
0110	TAP	TAB	BNE	PSHA	ROR			LDA			LDA				
0111	TPA	TBA	BEO	PSHB	ASR			STA			STA				
1000	INX	PG.2	BVC	PULX	ASL			EOR			EOR				
1001	DEX	DAA	BVS	RTS	ROL			ADC			ADC				
1010	CLV	PG.3	BPL	ABX	DEC			ORA			ORA				
1011	SEV	ABA	BMI	RTI	INC			ADD			ADD				
1100	CLC	BSET	BGE	PSHX	INC			CPX			LDD				
1101	SEC	BCLR	BLT	MUL	TST			JSR			PG.4				
1110	CLI	BRSET	BGT	WAI	JMP			LDS			LDS				
1111	SEI	BRCLR	BLE	SWI	CLR			XGDX			STS				
										A	B	C	D	E	F

IND,X

DIR

# Freescale Semiconductor, Inc.

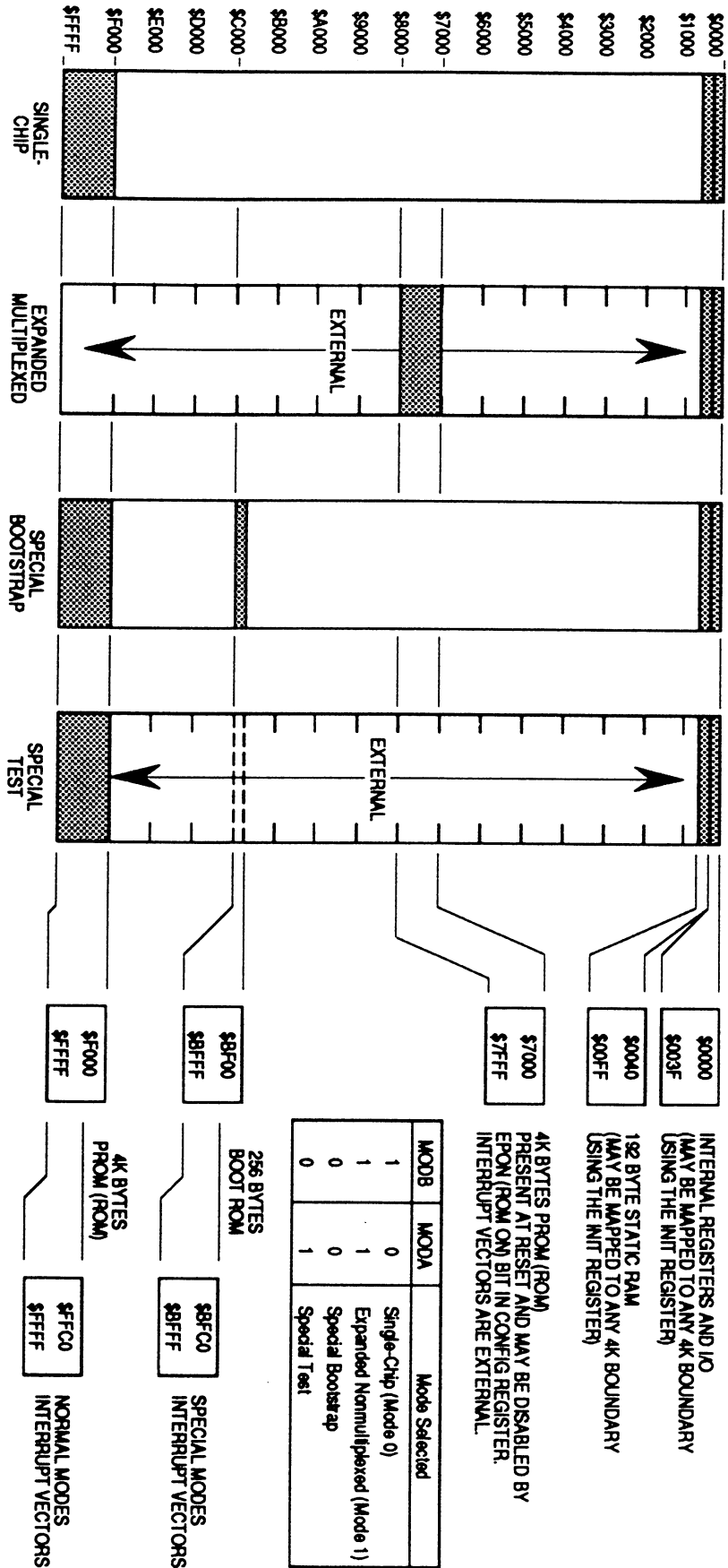

For More Information On This Product,  
[www.freescale.com](http://www.freescale.com)

**OPCODE MAP (PAGE 2) (18 xx)**

MSB LSB	INH				IND,Y				ACCA				ACCB			
	0000	0001	0010	0011	0100	0101	0110	0111	1000	1001	1010	1011	1100	1101	1110	1111
0	0	1	2	3	4	5	6	7	8	9	A	B	C	D	E	F
0000				TSY			NEG									
0001																
0010																
0011																
0100						COM										
0101						LSR										
0110																
0111																
1000																
1001																
1010																
1011																
1100																
1101																
1110																
1111																

IND,Y





**OPCODE MAP (PAGE 3) (1AXx)**

MSB	0000	0001	0010	0011	0100	0101	0110	0111	ACCA				ACCB			
									IMM	DIR	IND,X	EXT	IMM	DIR	IND,X	EXT
LSB	0	1	2	3	4	5	6	7	8	9	A	B	C	D	E	F
0000	0	1	2	3	4	5	6	7	8	9	A	B	C	D	E	F
0001	0	1	2	3	4	5	6	7	8	9	A	B	C	D	E	F
0010	0	1	2	3	4	5	6	7	8	9	A	B	C	D	E	F
0011	0	1	2	3	4	5	6	7	8	9	A	B	C	D	E	F
0100	0	1	2	3	4	5	6	7	8	9	A	B	C	D	E	F
0101	0	1	2	3	4	5	6	7	8	9	A	B	C	D	E	F
0110	0	1	2	3	4	5	6	7	8	9	A	B	C	D	E	F
0111	0	1	2	3	4	5	6	7	8	9	A	B	C	D	E	F
1000	0	1	2	3	4	5	6	7	8	9	A	B	C	D	E	F
1001	0	1	2	3	4	5	6	7	8	9	A	B	C	D	E	F
1010	0	1	2	3	4	5	6	7	8	9	A	B	C	D	E	F
1011	0	1	2	3	4	5	6	7	8	9	A	B	C	D	E	F
1100	0	1	2	3	4	5	6	7	8	9	A	B	C	D	E	F
1101	0	1	2	3	4	5	6	7	8	9	A	B	C	D	E	F
1110	0	1	2	3	4	5	6	7	8	9	A	B	C	D	E	F
1111	0	1	2	3	4	5	6	7	8	9	A	B	C	D	E	F

**OPCODE MAP (PAGE 4)(CDxx)**

MSB LSB	0000		0001		0010		0011		0100		0101		0110		0111		ACCA				ACCB				
	0	1	2	3	4	5	6	7	8	9	A	B	C	D	E	F	1000	1001	1010	1011	1100	1101	1110	1111	
0000	0																								
0001	1																								
0010	2																								
0011	3																								
0100	4																								
0101	5																								
0110	6																								
0111	7																								
1000	8																								
1001	9																								
1010	A																								
1011	B																								
1100	C																								
1101	D																								
1110	E																								
1111	F																								
0	1	2	3	4	5	6	7	8	9	A	B	C	D	E	F	1000	1001	1010	1011	1100	1101	1110	1111	F	

For More Information On This Product,  
Go to: [www.freescale.com](http://www.freescale.com)



**SIMPLE BRANCHES**

Mnemonic	Opcode	Cycles
BRA	20	3
BRN	21	3
BSR	8D	7

**SIMPLE CONDITIONAL BRANCHES**

Test	True Opcode	False Opcode
N = 1	BMI 2B	BPL 2A
Z = 1	BEQ 27	BNE 26
V = 1	BVS 29	BVC 28
C = 1	BCS 25	BCC 24

**SIGNED CONDITIONAL BRANCHES**

Test	True Opcode	False Opcode
r > m	BGT 2E	BLE 2F
r ≥ m	BGE 2C	BLT 2D
r = m	BEQ 27	BNE 26
r ≤ m	BLE 2F	BGT 2E
r < m	BLT 2D	BGE 2C

**UNSIGNED CONDITIONAL BRANCHES**

Test	True Opcode	False Opcode
r > m	BHI 22	BLS 23
r ≥ m	BHS/BCC 24	BLO/BCS 25
r = m	BEQ 27	BNE 26
r ≤ m	BLS 23	BHI 22
r < m	BLO/BCS 25	BHS/BCC 24

**BIT MANIPULATION BRANCHES**

**BRCLR** — Branch if all selected bits are clear (opcode) (operand addr) (mask) (rel offset).  
 $M \cdot mm = 0$ ? M = operand in memory; mm — mask

**BRSET** — Branch if all selected bits are set (opcode) (operand addr) (mask) (rel offset).  
 $(\overline{M}) \cdot mm = 0$ ? M = operand in memory; mm mask



**Freescale Semiconductor, Inc.**  
**Opcode vs Instruction Cross Reference**

Opcode	Operands	Instruction	ADDR Mode	Cycle
00		TEST	INH	—
01		NOP	INH	2
02		IDIV	INH	41
03		FDIV	INH	41
04		LSRD	INH	3
05		ASLD/LSLD	INH	3
06		TAP	INH	2
07		TPA	INH	2
08		INX	INH	3
09		DEX	INH	3
0A		CLV	INH	2
0B		SEV	INH	2
0C		CLC	INH	2
0D		SEC	INH	2
0E		CLI	INH	2
0F		SEI	INH	2
10		SBA	INH	2
11		CBA	INH	2
12	dd mm rr	BRSET (opr) (msk) (rel)	DIR	6
13	dd mm rr	BRCLR (opr) (msk) (rel)	DIR	6
14	dd mm	BSET (opr) (msk)	DIR	6
15	dd mm	BCLR (opr) (msk)	DIR	6
16		TAB	INH	2
17		TBA	INH	2
18		(Page 2 Switch)		
19		DAA	INH	2
1A		(Page 3 Switch)		
1B		ABA	INH	2
1C	ff mm	BSET (opr) (msk)	IND,X	7
1D	ff mm	BCLR (opr) (msk)	IND,X	7
1E	ff mm rr	BRSET (opr) (msk) (rel)	IND,X	7
1F	ff mm rr	BRCLR (opr) (msk) (rel)	IND,X	7



# Freescale Semiconductor, Inc.

## Opcode Vs Instruction Cross Reference

Opcode	Operands	Instruction	ADDR Mode	Cycle
20	rr	BRA (rel)	REL	3
21	rr	BRN (rel)	REL	3
22	rr	BHI (rel)	REL	3
23	rr	BLS (rel)	REL	3
24	rr	BCC/BHS (rel)	REL	3
25	rr	BCS/BLO (rel)	REL	3
26	rr	BNE (rel)	REL	3
27	rr	BEQ (rel)	REL	3
28	rr	BVC (rel)	REL	3
29	rr	BVS (rel)	REL	3
2A	rr	BPL (rel)	REL	3
2B	rr	BMI (rel)	REL	3
2C	rr	BGE (rel)	REL	3
2D	rr	BLT (rel)	REL	3
2E	rr	BGT (rel)	REL	3
2F	rr	BLE (rel)	REL	3
30		TSX	INH	3
31		INS	INH	3
32		PULA	INH	4
33		PULB	INH	4
34		DES	INH	3
35		TXS	INH	3
36		PSHA	INH	3
37		PSHB	INH	3
38		PULX	INH	5
39		RTS	INH	5
3A		ABX	INH	3
3B		RTI	INH	12
3C		PSHX	INH	4
3D		MUL	INH	10
3E		WAI	INH	14
3F		SWI	INH	14
40		NEGA	INH	2
43		COMA	INH	2
44		LSRA	INH	2
46		RORA	INH	2
47		ASRA	INH	2
48		ASLA/LSLA	INH	2
49		ROLA	INH	2
4A		DECA	INH	2
4C		INCA	INH	2
4D		TSTA	INH	2
4F		CLRA	INH	2
50		NEGB	INH	2



## Freescale Semiconductor, Inc. Opcode vs Instruction Cross Reference

Opcode	Operands	Instruction	ADDR Mode	Cycle
53		COMB	INH	2
54		LSRB	INH	2
56		RORB	INH	2
57		ASRB/ASLB	INH	2
58		LSLB	INH	2
59		ROLB	INH	2
5A		DECB	INH	2
5C		INCB	INH	2
5D		TSTB	INH	2
5F		CLRB	INH	2
60	ff	NEG (opr)	IND,X	6
63	ff	COM (opr)	IND,X	6
64	ff	LSR (opr)	IND,X	6
66	ff	ROR (opr)	IND,X	6
67	ff	ASR (opr)	IND,X	6
68	ff	ASL/LSL (opr)	IND,X	6
69	ff	ROL (opr)	IND,X	6
6A	ff	DEC (opr)	IND,X	6
6C	ff	INC (opr)	IND,X	6
6D	ff	TST (opr)	IND,X	6
6E	ff	JMP (opr)	IND,X	3
6F	ff	CLR (opr)	IND,X	6
70	hh ll	NEG (opr)	EXT	6
73	hh ll	COM (opr)	EXT	6
74	hh ll	LSR (opr)	EXT	6
76	hh ll	ROR (opr)	EXT	6
77	hh ll	ASR (opr)	EXT	6
78	hh ll	ASL/LSL (opr)	EXT	6
79	hh ll	ROL (opr)	EXT	6
7A	hh ll	DEC (opr)	EXT	6
7C	hh ll	INC (opr)	EXT	6
7D	hh ll	TST (opr)	EXT	6
7E	hh ll	JMP (opr)	EXT	3
7F	hh ll	CLR (opr)	EXT	6
80	ii	SUBA (opr)	IMM	2
81	ii	CMPA (opr)	IMM	2
82	ii	SBCA (opr)	IMM	2
83	jj kk	SUBD (opr)	IMM	4
84	ii	ANDA (opr)	IMM	2
85	ii	BITA (opr)	IMM	2
86	ii	LDAA (opr)	IMM	2
88	ii	EORA (opr)	IMM	2
89	ii	ADCA (opr)	IMM	2
8A	ii	ORAA (opr)	IMM	2

## Freescale Semiconductor, Inc. Opcode vs Instruction Cross Reference

Opcode	Operands	Instruction	ADDR Mode	Cycle
8B	ii	ADDA (opr)	IMM	2
8C	jj kk	CPX (opr)	IMM	4
8D	rr	BSR (rel)	REL	6
8E	jj kk	LDS (opr)	IMM	3
8F		XGDX	INH	3
90	dd	SUBA (opr)	DIR	3
91	dd	CMPA (opr)	DIR	3
92	dd	SBCA (opr)	DIR	3
93	dd	SUBD (opr)	DIR	5
94	dd	ANDA (opr)	DIR	3
95	dd	BITA (opr)	DIR	3
96	dd	LDAA (opr)	DIR	3
97	dd	STAA (opr)	DIR	3
98	dd	EORA (opr)	DIR	3
99	dd	ADCA (opr)	DIR	3
9A	dd	ORAA (opr)	DIR	3
9B	dd	ADDA (opr)	DIR	3
9C	dd	CPX (opr)	DIR	5
9D	dd	JSR (opr)	DIR	5
9E	dd	LDS (opr)	DIR	4
9F	dd	STS (opr)	DIR	4
A0	ff	SUBA (opr)	IND,X	4
A1	ff	CMPA (opr)	IND,X	4
A2	ff	SBCA (opr)	IND,X	4
A3	ff	SUBD (opr)	IND,X	6
A4	ff	ANDA (opr)	IND,X	4
A5	ff	BITA (opr)	IND,X	4
A6	ff	LDAA (opr)	IND,X	4
A7	ff	STAA (opr)	IND,X	4
A8	ff	EORA (opr)	IND,X	4
A9	ff	ADCA (opr)	IND,X	4
AA	ff	ORAA (opr)	IND,X	4
AB	ff	ADDA (opr)	IND,X	4
AC	ff	CPX (opr)	IND,X	6
AD	ff	JSR (opr)	IND,X	6
AE	ff	LDS (opr)	IND,X	5
AF	ff	STS (opr)	IND,X	5
B0	hh ll	SUBA (opr)	EXT	4
B1	hh ll	CMPA (opr)	EXT	4
B2	hh ll	SBCA (opr)	EXT	4
B3	hh ll	SUBD (opr)	EXT	6
B4	hh ll	ANDA (opr)	EXT	4
B5	hh ll	BITA (opr)	EXT	4
B6	hh ll	LDAA (opr)	EXT	4

**For More Information On This Product,  
Go to: [www.freescale.com](http://www.freescale.com)**

## Freescale Semiconductor, Inc. Opcode vs Instruction Cross Reference

Opcode	Operands	Instruction	ADDR Mode	Cycle
B7	hh ll	STAA (opr)	EXT	4
B8	hh ll	EORA (opr)	EXT	4
B9	hh ll	ADCA (opr)	EXT	4
BA	hh ll	ORAA (opr)	EXT	4
BB	hh ll	ADDA (opr)	EXT	4
BC	hh ll	CPX (opr)	EXT	6
BD	hh ll	JSR (opr)	EXT	6
BE	hh ll	LDS (opr)	EXT	5
BF	hh ll	STS (opr)	EXT	5
C0	ii	SUBB (opr)	IMM	2
C1	ii	CMPB (opr)	IMM	2
C2	ii	SBCB (opr)	IMM	2
C3	jj kk	ADDD (opr)	IMM	4
C4	ii	ANDB (opr)	IMM	2
C5	ii	BITB (opr)	IMM	2
C6	ii	LDAB (opr)	IMM	2
C8	ii	EORB (opr)	IMM	2
C9	ii	ADCB (opr)	IMM	2
CA	ii	ORAB (opr)	IMM	2
CB	ii	ADDB (opr)	IMM	2
CC	jj kk	LDD (opr)	IMM	3
CD		(Page 4 Switch)		
CE	jj kk	LDX (opr)	IMM	3
CF		STOP	INH	2
D0	dd	SUBB (opr)	DIR	3
D1	dd	CMPB (opr)	DIR	3
D2	dd	SBCB (opr)	DIR	3
D3	dd	ADDD (opr)	DIR	5
D4	dd	ANDB (opr)	DIR	3
D5	dd	BITB (opr)	DIR	3
D6	dd	LDAB (opr)	DIR	3
D7	dd	STAB (opr)	DIR	3
D8	dd	EORB (opr)	DIR	3
D9	dd	ADCB (opr)	DIR	3
DA	dd	ORAB (opr)	DIR	3
DB	dd	ADDB (opr)	DIR	3
DC	dd	LDD (opr)	DIR	4
DD	dd	STD (opr)	DIR	4
DE	dd	LDX (opr)	DIR	4
DF	dd	STX (opr)	DIR	4
E0	ff	SUBB (opr)	IND,X	4
E1	ff	CMPB (opr)	IND,X	4
E2	ff	SBCB (opr)	IND,X	4
E3	ff	ADDD (opr)	IND,X	6

## Freescale Semiconductor, Inc. Opcode vs Instruction Cross Reference

Opcode	Operands	Instruction	ADDR Mode	Cycle
E4	ff	ANDB (opr)	IND,X	4
E5	ff	BITB (opr)	IND,X	4
E6	ff	LDAB (opr)	IND,X	4
E7	ff	STAB (opr)	IND,X	4
E8	ff	EORB (opr)	IND,X	4
E9	ff	ADCB (opr)	IND,X	4
EA	ff	ORAB (opr)	IND,X	4
EB	ff	ADDB (opr)	IND,X	4
EC	ff	LDD (opr)	IND,X	5
ED	ff	STD (opr)	IND,X	5
EE	ff	LDX (opr)	IND,X	5
EF	ff	STX (opr)	IND,X	5
F0	hh ll	SUBB (opr)	EXT	4
F1	hh ll	CMPB (opr)	EXT	4
F2	hh ll	SBCB (opr)	EXT	4
F3	hh ll	ADDD (opr)	EXT	6
F4	hh ll	ANDB (opr)	EXT	4
F5	hh ll	BITB (opr)	EXT	4
F6	hh ll	LDAB (opr)	EXT	4
F7	hh ll	STAB (opr)	EXT	4
F8	hh ll	EORB (opr)	EXT	4
F9	hh ll	ADCB (opr)	EXT	4
FA	hh ll	ORAB (opr)	EXT	4
FB	hh ll	ADDB (opr)	EXT	4
FC	hh ll	LDD (opr)	EXT	5
FD	hh ll	STD (opr)	EXT	5
FE	hh ll	LDX (opr)	EXT	5
FF	hh ll	STX (opr)	EXT	5
18 08		INY	INH	4
18 09		DEY	INH	4
18 1C	ff mm	BSET (opr) (msk)	IND,Y	8
18 1D	ff mm	BCLR (opr) (msk)	IND,Y	8
18 1E	ff mm rr	BRSET (opr) (msk) (rel)	IND,Y	8
18 1F	ff mm rr	BRCLR (opr) (msk) (rel)	IND,Y	8
18 30		TSY	INH	4
18 35		TYS	INH	4
18 38		PULY	INH	6
18 3A		ABY	INH	4

**For More Information On This Product,  
Go to: [www.freescale.com](http://www.freescale.com)**

## Freescale Semiconductor, Inc. Opcode vs Instruction Cross Reference

Opcode	Operands	Instruction	ADDR Mode	Cycle
18 3C		PSHY	INH	5
18 60	ff	NEG (opr)	IND,Y	7
18 63	ff	COM (opr)	IND,Y	7
18 64	ff	LSR (opr)	IND,Y	7
18 66	ff	ROR (opr)	IND,Y	7
18 67	ff	ASR (opr)	IND,Y	7
18 68	ff	ASL/LSL (opr)	IND,Y	7
18 69	ff	ROL (opr)	IND,Y	7
18 6A	ff	DEC (opr)	IND,Y	7
18 6C	ff	INC (opr)	IND,Y	7
18 6D	ff	TST (opr)	IND,Y	7
18 6E	ff	JMP (opr)	IND,Y	4
18 6F	ff	CLR (opr)	IND,Y	7
18 8C	jj kk	CPY (opr)	IMM	5
18 8F		XGDY	INH	4
18 9C	dd	CPY (opr)	DIR	6
18 A0	ff	SUBA (opr)	IND,Y	5
18 A1	ff	CMPA (opr)	IND,Y	5
18 A2	ff	SBCA (opr)	IND,Y	5
18 A3	ff	SUBD (opr)	IND,Y	7
18 A4	ff	ANDA (opr)	IND,Y	5
18 A5	ff	BITA (opr)	IND,Y	5
18 A6	ff	LDAA (opr)	IND,Y	5
18 A7	ff	STAA (opr)	IND,Y	5
18 A8	ff	EORA (opr)	IND,Y	5
18 A9	ff	ADCA (opr)	IND,Y	5
18 AA	ff	ORAA (opr)	IND,Y	5
18 AB	ff	ADDA (opr)	IND,Y	5
18 AC	ff	CPY (opr)	IND,Y	7
18 AD	ff	JSR (opr)	IND,Y	7
18 AE	ff	LDS (opr)	IND,Y	6
18 AF	ff	STS (opr)	IND,Y	6
18 BC	hh ll	CPY (opr)	EXT	7
18 CE	jj kk	LDY (opr)	IMM	4
18 DE	dd	LDY (opr)	DIR	5
18 DF	dd	STY (opr)	DIR	5
18 E0	ff	SUBB (opr)	IND,Y	5
18 E1	ff	CMPB (opr)	IND,Y	5
18 E2	ff	SBCB (opr)	IND,Y	5
18 E3	ff	ADDD (opr)	IND,Y	5
18 E4	ff	ANDB (opr)	IND,Y	5
18 E5	ff	BITB (opr)	IND,Y	5
18 E6	ff	LDAB (opr)	IND,Y	5
18 E7	ff	STAB (opr)	IND,Y	5

# Freescale Semiconductor, Inc.

## Opcode vs Instruction Cross Reference

Opcode	Operands	Instruction	ADDR Mode	Cycle
18 E8	ff	EORB (opr)	IND,Y	5
18 E9	ff	ADCB (opr)	IND,Y	5
18 EA	ff	ORAB (opr)	IND,Y	5
18 EB	ff	ADDB (opr)	IND,Y	5
18 EC	ff	LDD (opr)	IND,Y	6
18 ED	ff	STD (opr)	IND,Y	6
18 EE	ff	LDY (opr)	IND,Y	6
18 EF	ff	STY (opr)	IND,Y	6
18 FE	hh ll	LDY (opr)	EXT	6
18 FF	hh ll	STY (opr)	EXT	6
1A 83	jj kk	CPD (opr)	IMM	5
1A 93	dd	CPD (opr)	DIR	6
1A A3	ff	CPD (opr)	IND,X	7
1A AC	ff	CPY (opr)	IND,X	7
1A B3	hh ll	CPD (opr)	EXT	7
1A EE	ff	LDY (opr)	IND,X	6
1A EF	ff	STY (opr)	IND,X	6
CD A3	ff	CPD (opr)	IND,Y	7
CD AC	ff	CPX (opr)	IND,Y	7
CD EE	ff	LDX (opr)	IND,Y	6
CD EF	ff	STX (opr)	IND,Y	6

**NOTES:**

**Operands:**

- dd = 8-bit direct address \$0000-\$00FF. (High byte assumed to be \$00).
- ff = 8-bit positive offset \$00 (0) to \$FF (255) added to index.
- hh = High-order byte of 16-bit extended address
- ii = One byte of immediate data.
- jj = High-order byte of 16-bit immediate data.
- kk = Low-order byte of 16-bit immediate data.
- ll = Low-order byte of 16-bit extended address.
- mm = 8-bit mask (set bits to be effective).
- rr = Signed relative offset \$80 ( - 128) to \$7F ( - 127). Offset relative to the address following the machine code offset byte.



**INSTRUCTIONS, ADDRESSING MODES, AND EXECUTION TIMES**

Source Form(s)	Operation	Boolean Expression	Addressing Mode for Operand	Machine Coding (Hexadecimal)		Bytes	Cycles	Condition Codes							
				Opcode	Operand(s)			S	X	H	I	N	Z	V	C
ABA	Add Accumulators	$A + B \uparrow A$	INH	1B		1	2	—	—	—	—	—	—	—	—
ABX	Add B to X	$IX + 00: B \uparrow IX$	INH	3A		1	3	—	—	—	—	—	—	—	—
ABY	Add B to Y	$IY + 00: B \uparrow IY$	INH	18 3A		2	4	—	—	—	—	—	—	—	—
ADCA (opr)	Add with Carry to A	$A + M + C \uparrow A$	A IMM	89	ii	2	2	—	—	—	—	—	—	—	—
			A DIR	99	dd	2	3	—	—	—	—	—	—	—	—
			A EXT	B9	hh ll	3	4	—	—	—	—	—	—	—	—
			A IND,X	A9	ff	2	4	—	—	—	—	—	—	—	—
			A IND,Y	A9 18	ff	3	5	—	—	—	—	—	—	—	—
ADCB (opr)	Add with Carry to B	$B + M + C \uparrow B$	B IMM	C9	ii	2	2	—	—	—	—	—	—	—	—
			B DIR	D9	dd	2	3	—	—	—	—	—	—	—	
			B EXT	F9	hh ll	3	4	—	—	—	—	—	—	—	
			B IND,X	E9	ff	2	4	—	—	—	—	—	—	—	
			B IND,Y	E9 18	ff	3	5	—	—	—	—	—	—	—	





Source Form(s)	Operation	Boolean Expression	Addressing Mode for Operand	Machine Coding (Hexadecimal)		Bytes	Cycles	Condition Codes					
				Opcode	Operand(s)			S X H I N Z V C					
ADDA (opr)	Add Memory to A	$A + M \blacktriangleright A$	A IMM A DIR A EXT A IND,X A IND,Y	8B	ii	2	2	—	—	—	—	—	—
				9B	dd	2		—	—	—	—	—	
				BB	hh ll	3		—	—	—	—	—	
				AB	ff	2		—	—	—	—	—	
				18 AB	ff	3		—	—	—	—	—	
ADDB (opr)	Add Memory to B	$B + M \blacktriangleright B$	B IMM B DIR B EXT B IND,X B IND,Y	CB	ii	2	2	—	—	—	—	—	—
				DB	dd	2		—	—	—	—	—	
				FB	hh ll	3		—	—	—	—	—	
				EB	ff	2		—	—	—	—	—	
				18 EB	ff	3		—	—	—	—	—	
ADDD (opr)	Add 16-Bit to D	$D + M : M + 1 \blacktriangleright D$	IMM DIR EXT IND,X IND,Y	C3	jj kk	3	3	—	—	—	—	—	—
				D3	dd	2		—	—	—	—	—	
				F3	hh ll	3		—	—	—	—	—	
				E3	ff	2		—	—	—	—	—	
				18 E3	ff	3		—	—	—	—	—	

ANDA (opr)	AND A with Memory	A • M → A	A IMM	84	ii	2	2	2	0
			A DIR	94	dd	2	3	3	↔ ↔
			A EXT	B4	hh	3	4	4	↔ ↔
			A IND,X	A4	ff	2	4	4	↔ ↔
			A IND,Y	A4 18	ff	3	5	5	↔ ↔
ANDB (opr)	AND B with Memory	B • M → B	B IMM	C4	ii	2	2	2	0
			B DIR	D4	dd	2	3	3	↔ ↔
			B EXT	F4	hh	3	4	4	↔ ↔
			B IND,X	E4	ff	2	4	4	↔ ↔
			B IND,Y	E4 18	ff	3	5	5	↔ ↔
ASL (opr)	Arithmetic Shift Left		EXT	78	hh	3	3	↔ ↔	
			IND,X	68	ff	2	6	6	↔ ↔
			IND,Y	68 18	ff	3	7	7	↔ ↔
ASLA			A INH	48		1	2		
ASLB			B INH	58		1	2		
ASLD	Arithmetic Shift Left Double		INH	05		1	3	↔ ↔	

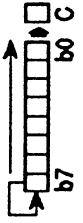

Source Form(s)	Operation	Boolean Expression	Addressing Mode for Operand	Machine Coding (Hexadecimal)		Bytes	Cycles	Condition Codes	
				Opcode	Operand(s)			S X H I N Z V C	
ASR (opr)	Arithmetic Shift Right		EXT IND,X IND,Y A INH B INH	77 67 18 67 47 57	hh ll ff ff	3 2 3 1 1	6 6 7 2 2	— — — — —	— — — — —
ASRA ASRB								— — — — —	— — — — —
BCC (rel)	Branch if Carry Clear	? C = 0	REL	24	rr	2	3	— — — — —	— — — — —
BCLR (opr) (msk)	Clear Bit(s)	$M \cdot (\overline{mm}) \rightarrow M$	DIR IND,X IND,Y	15 1D 18 1D	dd mm ff mm ff mm	3 3 4	6 7 8	— — — — —	— — — — —
BCS (rel)	Branch if Carry Clear	? C = 1	REL	25	rr	2	3	— — — — —	— — — — —
BEQ (rel)	Branch if = Zero	? Z = 1	REL	27	rr	2	3	— — — — —	— — — — —
BGE (rel)	Branch if ≥ Zero	? N ⊕ V = 0	REL	2C	rr	2	3	— — — — —	— — — — —
BGT (rel)	Branch if > Zero	? Z + (N ⊕ V) = 0	REL	2E	rr	2	3	— — — — —	— — — — —
BHI (rel)	Branch if Higher	? C + Z = 0	REL	22	rr	2	3	— — — — —	— — — — —

BHS (rel)	Branch if Higher or Same	? C = 0	REL	24	rr	2	3	---	---	---	---	---	---
BITA (opr)	Bit(s) Test A with Memory	A • M	A IMM A DIR A EXT A IND,X A IND,Y	85 95 B5 A5 18 A5	ii dd hh ff ff	2 2 3 2 3	2 3 4 4 5	---	---	---	---	---	0
BITB (opr)	Bit(s) Test B with Memory	B • M	B IMM B DIR B EXT B IND,X B IND,Y	C5 D5 F5 E5 18 E5	ii dd hh ff ff	2 2 3 2 3	2 3 4 4 5	---	---	---	---	---	0
BLE (rel)	Branch if ≤ Zero	? Z + (N ⊕ V) = 1	REL	2F	rr	2	3	---	---	---	---	---	---
BLO (rel)	Branch if Lower	? C = 1	REL	25	rr	2	3	---	---	---	---	---	---
BLS (rel)	Branch if Lower or Same	? C + Z = 1	REL	23	rr	2	3	---	---	---	---	---	---
BLT (rel)	Branch If < Zero	? N ⊕ V = 1	REL	2D	rr	2	3	---	---	---	---	---	---
BMI (rel)	Branch if Minus	? N = 1	REL	2B	rr	2	3	---	---	---	---	---	---
BNE (rel)	Branch if Not = Zero	? Z = 0	REL	26	rr	2	3	---	---	---	---	---	---
BPL (rel)	Branch if Plus	? N = 0	REL	2A	rr	2	3	---	---	---	---	---	---



Source Form(s)	Operation	Boolean Expression	Addressing Mode for Operand	Machine Coding (Hexadecimal)		Bytes	Cycles	Condition Codes							
				Opcode	Operand(s)			S	X	H	I	N	Z	V	C
BRA (rel)	Branch Always	? 1 = 1	REL	20	rr	2	3	—	—	—	—	—	—	—	—
BRCLR(opr) (msk) (rel)	Branch if Bit(s) Clear	? M • mm = 0	DIR IND,X IND,Y	13 1F 18 1F	dd ff ff	4 4 5	6 7 8	—	—	—	—	—	—	—	—
BRN (rel)	Branch Never	? 1 = 0	REL	21	rr	2	3	—	—	—	—	—	—	—	—
BRSET(opr) (msk) (rel)	Branch if Bit(s) Set	? (M) • mm = 0	DIR IND,X IND,Y	12 1E 18 1E	dd ff ff	4 4 5	6 7 8	—	—	—	—	—	—	—	—
BSET (opr) (msk)	Set Bit(s)	M + mm ♦ M	DIR IND,X IND,Y	14 1C 18 1C	dd ff ff	3 3 4	6 7 8	—	—	—	—	—	—	—	—
BSR (rel)	Branch to Subroutine	See Special Ops	REL	8D	rr	2	6	—	—	—	—	—	—	—	—
BVC (rel)	Branch if Overflow Clear	? V = 0	REL	28	rr	2	3	—	—	—	—	—	—	—	—
BVS (rel)	Branch if Overflow Set	? V = 1	REL	29	rr	2	3	—	—	—	—	—	—	—	—

CBA	Compare A to B	A-B	INH	11			1	2	— — — — —	◆ ◆ ◆ ◆
CLC	Clear Carry Bit	0 C	INH	0C			1	2	— — — — — 0	◆ ◆ ◆ ◆
CLI	Clear Interrupt Mask	0 I	INH	0E			1	2	— — — — 0 — — — —	◆ ◆ ◆ ◆
CLR (opr)	Clear Memory Byte	0 M	EXT	7F	hh	II	3	6	— — — — — 0 1 0 0	◆ ◆ ◆ ◆
			IND,X	6F	ff		2	6		
			IND,Y	18 6F	ff		3	7		
CLRA	Clear Accumulator A	0 A	A INH	4F			1	2	— — — — — 0 1 0 0	◆ ◆ ◆ ◆
CLRB	Clear Accumulator B	0 B	B INH	5F			1	2	— — — — — 0 1 0 0	◆ ◆ ◆ ◆
CLV	Clear Overflow Flag	0 V	INH	0A			1	2	— — — — — 0 — — — —	◆ ◆ ◆ ◆
CMPA (opr)	Compare A to Memory	A-M	A IMM	81	ii		2	2	— — — — — ◆ ◆ ◆ ◆	◆ ◆ ◆ ◆
			A DIR	91	dd		2	3		
			A EXT	B1	hh	II	3	4		
			A IND,X	A1	ff		2	4		
			A IND,Y	18 A1	ff		3	5		





Source Form(s)	Operation	Boolean Expression	Addressing Mode for Operand	Machine Coding (Hexadecimal)		Bytes	Cycles	Condition Codes											
				Opcode	Operand(s)			S	X H I N Z V C										
CMPB (opr)	Compare B to Memory	B-M	B IMM	C1	ii	2	2	—	—	—	—	—	—	—	—	—	—	—	
			B DIR	D1	dd	2	3	—	—	—	—	—	—	—	—	—	—	—	—
			B EXT	F1	hh ll	3	4	—	—	—	—	—	—	—	—	—	—	—	—
			B IND,X	E1	ff	2	4	—	—	—	—	—	—	—	—	—	—	—	—
			B IND,Y	18 E1	ff	3	5	—	—	—	—	—	—	—	—	—	—	—	—
COM (opr)	Ones Complement Memory Byte	\$FF-M ♦ M	EXT	73	hh ll	3	6	—	—	—	—	—	—	—	—	—	—	—	
			IND,X	63	ff	2	6	—	—	—	—	—	—	—	—	—	—	—	
			IND,Y	18 63	ff	3	7	—	—	—	—	—	—	—	—	—	—	—	
COMA	Ones Complement A	\$FF-A ♦ A	A INH	43		1	2	—	—	—	—	—	—	—	—	—	—		
COMB	Ones Complement B	\$FF-B ♦ B	B INH	53		1	2	—	—	—	—	—	—	—	—	—	—		
CPD (opr)	Compare D to Memory 16-Bit	D - M:M + 1	IMM	1A 83	jj kk	4	5	—	—	—	—	—	—	—	—	—	—	—	
			DIR	1A 93	dd	3	6	—	—	—	—	—	—	—	—	—	—	—	—
			EXT	1A B3	hh ll	4	7	—	—	—	—	—	—	—	—	—	—	—	—
			IND,X	1A A3	ff	3	7	—	—	—	—	—	—	—	—	—	—	—	—
			IND,Y	CD A3	ff	3	7	—	—	—	—	—	—	—	—	—	—	—	—



CPX (opr)	Compare X to Memory 16-Bit	IX - M:M + 1	IMM DIR EXT IND,X IND,Y	8C 9C BC AC CD AC	ij dd hh ff ff	kk ll	3 2 3 2 3	4 5 6 6 7	— — — — —	◆◆ ◆◆ ◆◆ ◆◆ ◆◆
CPY (opr)	Compare Y to Memory 16-Bit	IY - M:M + 1	IMM DIR EXT IND,X IND,Y	18 8C 18 9C 18 BC 1A AC 18 AC	ij dd hh ff ff	kk ll	4 3 4 3 3	5 6 7 7 7	— — — — —	◆◆ ◆◆ ◆◆ ◆◆ ◆◆
DAA	Decimal Adjust A	Adjust Sum to BCD	INH	19			1	2	— — — — —	◆◆ ◆◆ ◆◆ ◆◆ ◆◆
DEC (opr)	Decrement Memory Byte	M - 1 ↗ M	EXT IND,X IND,Y	7A 6A 18 6A	hh ff ff	ll	3 2 3	6 6 7	— — — — —	◆◆ ◆◆ ◆◆ ◆◆ ◆◆
DECA	Decrement Accumulator A	A - 1 ↗ A	A INH	4A			1	2	— — — — —	◆◆ ◆◆ ◆◆ ◆◆ ◆◆
DECB	Decrement Accumulator B	B - 1 ↗ B	B INH	5A			1	2	— — — — —	◆◆ ◆◆ ◆◆ ◆◆ ◆◆
DES	Decrement Stack Pointer	SP - 1 ↗ SP	INH	34			1	3	— — — — —	◆◆ ◆◆ ◆◆ ◆◆ ◆◆





Source Form(s)	Operation	Boolean Expression	Addressing Mode for Operand	Machine Coding (Hexadecimal)		Bytes	Cycles	Condition Codes										
				Opcode	Operand(s)			S	X	H	I	N	Z	V	C			
DEX	Decrement Index Register X	$IX - 1 \blacktriangleright IX$	INH	09		1	3	—	—	—	—	—	—	—	—			
DEY	Decrement Index Register Y	$IY - 1 \blacktriangleright IY$	INH	18 09		2	4	—	—	—	—	—	—	—	—			
EORA (opr)	Exclusive OR A with Memory	$A \oplus M \blacktriangleright A$	A IMM A DIR A EXT A IND,X A IND,Y	88	ii	2	2	—	—	—	—	—	—	—	—	—		
				98	dd	2	3	—	—	—	—	—	—	—	—	—	—	
				B8	hh	3	4	—	—	—	—	—	—	—	—	—	—	—
				A8	ff	2	4	—	—	—	—	—	—	—	—	—	—	—
				18 A8	ff	3	5	—	—	—	—	—	—	—	—	—	—	—
EORB (opr)	Exclusive OR B with Memory	$B \oplus M \blacktriangleright B$	B IMM B DIR B EXT B IND,X B IND,Y	C8	ii	2	2	—	—	—	—	—	—	—	—	—		
				D8	dd	2	3	—	—	—	—	—	—	—	—	—	—	
				F8	hh	3	4	—	—	—	—	—	—	—	—	—	—	—
				E8	ff	2	4	—	—	—	—	—	—	—	—	—	—	—
				18 E8	ff	3	5	—	—	—	—	—	—	—	—	—	—	—
FDIV	Fractional Divide 16 by 16	$D/IX \blacktriangleright IX; r \blacktriangleright D$	INH	03		1	41	—	—	—	—	—	—	—	—			
IDIV	Integer Divide 16 by 16	$D/IX \blacktriangleright IX; r \blacktriangleright D$	INH	02		1	41	—	—	—	—	—	—	—	—			

<b>Freescale Semiconductor, Inc.</b>									
INC (opr)	Increment Memory Byte	M + 1 $\blacktriangleright$ M	EXT IND,X IND,Y	7C 6C 18 6C	hh ff ff	ll	3 2 3	6 6 7	◆◆ ◆◆ ◆◆
INCA	Increment Accumulator A	A + 1 $\blacktriangleright$ A	A INH	4C			1	2	◆◆ ◆◆
INCB	Increment Accumulator B	B + 1 $\blacktriangleright$ B	B INH	5C			1	2	◆◆ ◆◆
INS	Increment Stack Pointer	SP + 1 $\blacktriangleright$ SP	INH	31			1	3	◆◆ ◆◆
INX	Increment Index Register X	IX + 1 $\blacktriangleright$ IX	INH	08			1	3	◆◆
INY	Increment Index Register Y	IY + 1 $\blacktriangleright$ IY	INH	18 08			2	4	◆◆
JMP (opr)	Jump	See Special Ops	EXT IND,X IND,Y	7E 6E 18 6E	hh ff ff	ll	3 2 3	3 3 4	◆◆ ◆◆ ◆◆
JSR (opr)	Jump to Subroutine	See Special Ops	DIR EXT IND,X IND,Y	9D BD AD 18 AD	dd hh ff ff	ll	2 3 2 3	5 6 6 7	◆◆ ◆◆ ◆◆ ◆◆





Source Form(s)	Operation	Boolean Expression	Addressing Mode for Operand	Machine Coding (Hexadecimal)		Bytes	Cycles	Condition Codes								
				Opcode	Operand(s)			S	X	H	I	N	Z	V		
LDAA (opr)	Load Accumulator A	$M \spadesuit A$	A IMM	86	ii	2	2	—	—	—	—	—	—	—	0	
			A DIR	96	dd	2	3	—	—	—	—	—	—	—	—	—
			A EXT	B6	hh ll	3	4	—	—	—	—	—	—	—	—	—
			A IND,X	A6	ff	2	4	—	—	—	—	—	—	—	—	—
			A IND,Y	A6 18	ff	3	5	—	—	—	—	—	—	—	—	—
LDAB (opr)	Load Accumulator B	$M \spadesuit B$	B IMM	C6	ii	2	2	—	—	—	—	—	—	—	0	
			B DIR	D6	dd	2	3	—	—	—	—	—	—	—	—	
			B EXT	F6	hh ll	3	4	—	—	—	—	—	—	—	—	—
			B IND,X	E6	ff	2	4	—	—	—	—	—	—	—	—	—
			B IND,Y	E6 18	ff	3	5	—	—	—	—	—	—	—	—	—
LDD (opr)	Load Double Accumulator D	$M \spadesuit A, M + 1 \spadesuit B$	IMM	CC	jj kk	3	3	—	—	—	—	—	—	—	0	
			DIR	DC	dd	2	4	—	—	—	—	—	—	—	—	
			EXT	FC	hh ll	3	5	—	—	—	—	—	—	—	—	—
			IND,X	EC	ff	2	5	—	—	—	—	—	—	—	—	—
			IND,Y	EC 18	ff	3	6	—	—	—	—	—	—	—	—	—

LDS (opr)	Load Stack Pointer	M:M + 1 $\blacktriangleright$ SP	IMM DIR EXT IND,X IND,Y	8E 9E BE AE 18 AE	jj dd hh ff ff	kk ll	3 2 3 2 3	3 4 5 5 6	— — — — —	— — — — —	— — — — —	— — — — —		
LDX (opr)	Load Index Register X	M:M + 1 $\blacktriangleright$ IX	IMM DIR EXT IND,X IND,Y	CE DE FE EE CD EE	ij dd hh ff ff	kk ll	3 2 3 2 3	3 4 5 5 6	— — — — —	— — — — —	— — — — —	— — — — —		
LDY (opr)	Load Index Register Y	M:M + 1 $\blacktriangleright$ IY	IMM DIR EXT IND,X IND,Y	18 CE 18 DE 18 FE 1A EE 18 EE	ij dd hh ff ff	kk ll	4 3 4 3 3	4 5 6 6 6	— — — — —	— — — — —	— — — — —	— — — — —		
LSL (opr)	Logical Shift Left		EXT IND,X IND,Y	78 68 68 48 58	hh ff ff	ll	3 2 3 1 1	6 6 7 2 2	— — — — —	— — — — —	— — — — —	— — — — —		
			A INH	18	ff									
			B INH	58	ff									



Source Form(s)	Operation	Boolean Expression	Addressing Mode for Operand	Machine Coding (Hexadecimal)		Bytes	Cycles	Condition Codes							
				Opcode	Operand(s)			S	X	H	I	N	Z	V	C
LSLD	Logical Shift Left Double		INH	05		1	3	—	—	—	—	—	—	—	—
LSR (opr)	Logical Shift Right		EXT IND,X IND,Y A INH B INH	74 64 18 64 44 54	hh ll ff ff	3 2 3 1 1	6 6 7 2 2	—	—	—	0	—	—	—	—
LSRA															
LSRB															
LSRD	Logical Shift Right Double		INH	04		1	3	—	—	—	—	—	—	—	—
MUL	Multiply 8 by 8	$A \times B \rightarrow D$	INH	3D		1	10	—	—	—	—	—	—	—	—
NEG (opr)	Twos Complement Memory Byte	$0 - M \rightarrow M$	EXT IND,X IND,Y	70 60 18 60	hh ll ff ff	3 2 3	6 6 7	—	—	—	—	—	—	—	—
NEGA	Twos Complement A	$0 - A \rightarrow A$	A INH	40		1	2	—	—	—	—	—	—	—	—
NEGB	Twos Complement B	$0 - B \rightarrow B$	B INH	50		1	2	—	—	—	—	—	—	—	—

NOP	No Operation	No Operation	INH	01		1	2	
ORAA (opr)	OR Accumulator A (Inclusive)	No Operation A + M $\blacklozenge$ A	A IMM A DIR A EXT A IND,X A IND,Y	8A 9A BA AA AA 18 AA	ii dd hh ff ff	2 2 3 2 3	2 3 4 4 5	--- --- --- --- --- --- $\blacklozenge$ $\blacklozenge$ 0 ---
ORAB (opr)	OR Accumulator B (Inclusive)	B + M $\blacklozenge$ B	B IMM B DIR B EXT B IND,X B IND,Y	CA DA FA EA EA 18 EA	ii dd hh ff ff	2 2 3 2 3	2 3 4 4 5	--- --- --- --- $\blacklozenge$ $\blacklozenge$ 0 ---
PSHA	Push A onto Stack	A $\blacklozenge$ Stk, SP = SP - 1	A INH	36		1	3	---
PSHB	Push B onto Stack	B $\blacklozenge$ Stk, SP = SP - 1	B INH	37		1	3	---
PSHX	Push X onto Stack (Lo First)	IX $\blacklozenge$ Stk, SP = SP - 2	INH	3C		1	4	---
PSHY	Push Y onto Stack (Lo First)	IY $\blacklozenge$ Stk, SP = SP - 2	INH	18 3C		2	5	---
PULA	Pull A from Stack	SP = SP + 1, A $\blacklozenge$ Stk	A INH	32		1	4	---
PULB	Pull B from Stack	SP = SP + 1, B $\blacklozenge$ Stk	B INH	33		1	4	---

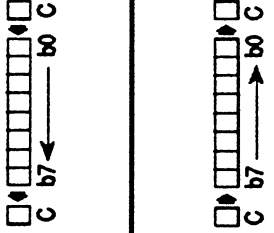
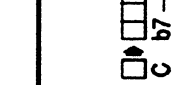

Source Form(s)	Operation	Boolean Expression	Addressing Mode for Operand	Machine Coding (Hexadecimal)		Bytes	Cycles	Condition Codes								
				Opcode	Operand(s)			S	X	H	I	N	Z	V	C	
PULX	Pull X from Stack (Hi First)	$SP = SP + 2, X \leftarrow Stk$	INH	38		1	5	—	—	—	—	—	—	—	—	
PULY	Pull Y from Stack (Hi First)	$SP = SP + 2, Y \leftarrow Stk$	INH	18 38		2	6	—	—	—	—	—	—	—	—	
ROL (opr)	Rotate Left		EXT IND,X IND,Y A INH B INH	79 69 18 69 49 59	hh ll ff ff ff	3 2 3 1 1	6 6 7 2 2	—	—	—	—	—	—	—	—	
ROLA																
ROLB																
ROR (opr)	Rotate Right		EXT IND,X IND,Y A INH B INH	76 66 18 66 46 56	hh ll ff ff ff	3 2 3 1 1	6 6 7 2 2	—	—	—	—	—	—	—	—	
RORA																
RORB																
RTI	Return from Interrupt	See Special Ops	INH	3B		1	12	—	—	—	—	—	—	—	—	—
RTS	Return from Subroutine	See Special Ops	INH	39		1	5	—	—	—	—	—	—	—	—	—
SBA	Subtract B from A	$A - B \leftarrow A$	INH	10		1	2	—	—	—	—	—	—	—	—	—



Freescale Semiconductor, Inc.

SBCA (opr)	Subtract with Carry from A	A ← M ← C ← A	A IMM A DIR A EXT A IND,X A IND,Y	82 92 B2 A2 18 A2	ii dd hh ff ff	2 2 3 2 3	2 3 4 4 5	--- --- --- --- ---	◆◆ ◆◆ ◆◆ ◆◆ ◆◆
SBCB (opr)	Subtract with Carry from B	B ← M ← C ← B	B IMM B DIR B EXT B IND,X B IND,Y	C2 D2 F2 E2 18 E2	ii dd hh ff ff	2 2 3 2 3	2 3 4 4 5	--- --- --- --- ---	◆◆ ◆◆ ◆◆ ◆◆ ◆◆
SEC	Set Carry	1 ← C	INH	OD		1	2	--- --- --- --- ---	1
SEI	Set Interrupt Mask	1 ← I	INH	OF		1	2	--- --- --- --- ---	1
SEV	Set Overflow Flag	1 ← V	INH	OB		1	2	--- --- --- --- ---	1
STAA (opr)	Store Accumulator A	A ← M	A DIR A EXT A IND,X A IND,Y	97 B7 A7 18 A7	dd hh ff ff	2 3 2 3	3 4 4 5	--- --- --- --- ---	◆◆ ◆◆ ◆◆ ◆◆ 0





**Freescale Semiconductor, Inc.**

Source Form(s)	Operation	Boolean Expression	Addressing Mode for Operand	Machine Coding (Hexadecimal)		Bytes	Cycles	Condition Codes											
				Opcode	Operand(s)			S	X	H	I	N	Z	V	C				
STAB (opr)	Store Accumulator B	B $\spadesuit$ M	B DIR B EXT B IND,X B IND,Y	D7	dd	2	3	---	---	---	---	---	---	---	---	0	---		
				F7	hh	3	4	---	---	---	---	---	---	---	---	---	---	---	
				E7	ff	2	4	---	---	---	---	---	---	---	---	---	---	---	---
				18	ff	3	5	---	---	---	---	---	---	---	---	---	---	---	---
STD (opr)	Store Accumulator D	A $\spadesuit$ M, B $\spadesuit$ M + 1	DIR EXT IND,X IND,Y	DD	dd	2	4	---	---	---	---	---	---	---	---	0	---		
				FD	hh	3	5	---	---	---	---	---	---	---	---	---	---	---	
				ED	ff	2	5	---	---	---	---	---	---	---	---	---	---	---	---
				18	ff	3	6	---	---	---	---	---	---	---	---	---	---	---	---
STOP	Stop Internal Clocks		INH	CF	1	2	---	---	---	---	---	---	---	---	---	---			
STS (opr)	Store Stack Pointer	SP $\spadesuit$ M:M + 1	DIR EXT IND,X IND,Y	9F	dd	2	4	---	---	---	---	---	---	---	---	0	---		
				BF	hh	3	5	---	---	---	---	---	---	---	---	---	---	---	
				AF	ff	2	5	---	---	---	---	---	---	---	---	---	---	---	---
				18	ff	3	6	---	---	---	---	---	---	---	---	---	---	---	---
STX (opr)	Store Index Register X	IX $\spadesuit$ M:M + 1	DIR EXT IND,X IND,Y	DF	dd	2	4	---	---	---	---	---	---	---	---	0	---		
				FF	hh	3	5	---	---	---	---	---	---	---	---	---	---	---	
				EF	ff	2	5	---	---	---	---	---	---	---	---	---	---	---	---
				CD	ff	3	6	---	---	---	---	---	---	---	---	---	---	---	---

STY (opr)	Store Index Register Y	Y $\blacktriangleright$ M:M+1	DIR EXT IND,X IND,Y	18 DF 18 FF 1A EF 18 EF	dd hh ff ff	ll	3 4 3 3	5 6 6 6	— — — —	— — — —	— — — —	— — — —
SUBA (opr)	Subtract Memory from A	A - M $\blacktriangleright$ A	A IMM A DIR A EXT A IND,X A IND,Y	80 90 B0 A0 A0	ii dd hh ff ff	ll	2 2 3 2 3	2 3 4 4 5	— — — — —	— — — — —	— — — — —	— — — — —
SUBB (opr)	Subtract Memory from B	B - M $\blacktriangleright$ B	B IMM B DIR B EXT B IND,X B IND,Y	C0 D0 F0 E0 E0	ii dd hh ff ff	ll	2 2 3 2 3	2 3 4 4 5	— — — — —	— — — — —	— — — — —	— — — — —
SUBD (opr)	Subtract Memory from D	D - M:M+1 $\blacktriangleright$ D	IMM DIR EXT IND,X IND,Y	83 93 B3 A3 A3	jj dd hh ff ff	kk ll	3 2 3 2 3	4 5 6 6 7	— — — — —	— — — — —	— — — — —	— — — — —
SWI	Software Interrupt	See Special Ops	INH	3F			1	14	— — — —	— — — —	— — — —	— — — —
TAB	Transfer A to B	A $\blacktriangleright$ B	INH	16			1	2	— — — —	— — — —	— — — —	— — — —



Source Form(s)	Operation	Boolean Expression	Addressing Mode for Operand	Machine Coding (Hexadecimal)		Bytes	Cycles	Condition Codes							
				Opcode	Operand(s)			S	X	H	I	N	Z	V	C
TAP	Transfer A to CC Register	A $\uparrow$ CCR	INH	06		1	2	$\leftrightarrow$	$\leftrightarrow$	$\leftrightarrow$	$\leftrightarrow$	$\leftrightarrow$	$\leftrightarrow$	$\leftrightarrow$	
TBA	Transfer B to A	B $\uparrow$ A	INH	17		1	2	—	—	—	$\leftrightarrow$	$\leftrightarrow$	0	—	
TEST	TEST (Only in Test Modes)	Address Bus Counts	INH	00		1	*	—	—	—	—	—	—	—	
TPA	Transfer CC Register to A	CCR $\uparrow$ A	INH	07		1	2	—	—	—	—	—	—	—	
TST (opr)	Test for Zero or Minus	M-0	EXT IND,X IND,Y	7D	hh ll	3	6	—	—	—	$\leftrightarrow$	$\leftrightarrow$	0	0	
				6D	ff	2	6	—	—	—	—	—	—	—	—
				18 6D	ff	3	7	—	—	—	—	—	—	—	—
TSTA		A-0	A INH	4D		1	2	—	—	—	$\leftrightarrow$	$\leftrightarrow$	0	0	
TSTB		B-0	B INH	5D		1	2	—	—	—	$\leftrightarrow$	$\leftrightarrow$	0	0	
TSX	Transfer Stack Pointer to X	SP+1 $\uparrow$ IX	INH	30		1	3	—	—	—	—	—	—	—	
TSY	Transfer Stack Pointer to Y	SP+1 $\uparrow$ IY	INH	18 30		2	4	—	—	—	—	—	—	—	
TXS	Transfer X to Stack Pointer	IX-1 $\uparrow$ SP	INH	35		1	3	—	—	—	—	—	—	—	

TYS	Transfer Y to Stack Pointer	IY - 1 $\blacktriangleright$ SP	INH	18 35	2 4	— — — — —
WAI	Wait for Interrupt	Stack Regs & WAIT	INH	3E	1 **	— — — — —
XGD <sub>X</sub>	Exchange D with X	IX $\blacktriangleright$ D, D $\blacktriangleright$ IX	INH	8F	1 3	— — — — —
XGD <sub>Y</sub>	Exchange D with Y	IY $\blacktriangleright$ D, D $\blacktriangleright$ IY	INH	18 8F	2 4	— — — — —

**NOTES:**

\* Infinity or until reset occurs

\*\* 12 cycles are used beginning with the opcode fetch. A wait state is entered which remains in effect for an integer number of MPU E-clock cycles (n) until an interrupt is recognized. Finally, two additional cycles are used to fetch the appropriate interrupt vector (14 + n total).

**Operands**

- dd 8-Bit Direct Address (\$000-\$00FF) (High Byte Assumed to be \$00)
- ff 8-Bit Positive offset \$00 (0) to \$FF (255) (Is Added to Index)
- hh High-Order Byte of 16-Bit Extended Address
- ii One Byte of Immediate Data
- jj High-Order Byte of 16-Bit Immediate Data
- kk Low-Order Byte of 16-Bit Immediate Data
- ll Low-Order byte of 16-Bit Extended Address
- mm 8-Bit Mask (Set Bits to be Affected)
- rr Signed Relative offset \$80 ( - 128) to \$7F ( - 127)  
(Offset Relative to the Address Following the Machine Code Offset Byte)

**Condition Codes**

- Bit not changed
- 0 Bit always cleared
- 1 Bit always set
- $\blacktriangleleft$  Bit cleared or set, depending on operation
- $\blacktriangleright$  Bit can be cleared, cannot become set



# Freescale Semiconductor, Inc. SPECIAL OPERATIONS

Freescale Semiconductor, Inc.

## JSR, JUMP TO SUBROUTINE

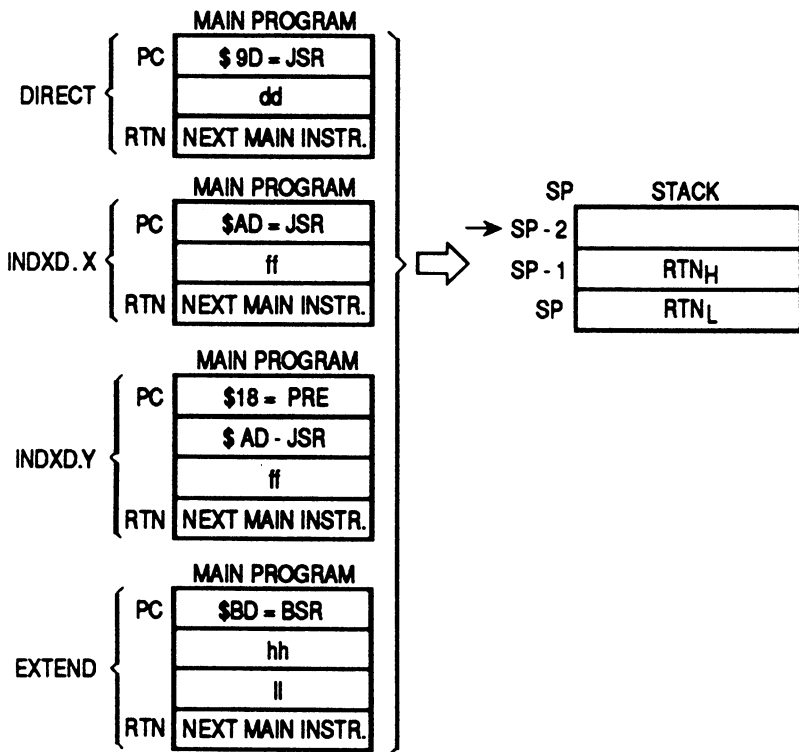

## BSR, BRANCH TO SUBROUTINE

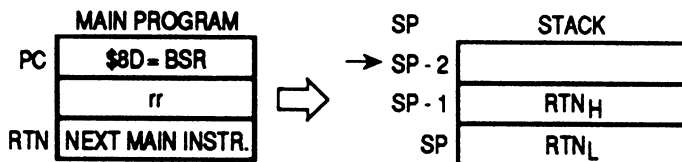

## RTS, RETURN FROM SUBROUTINE

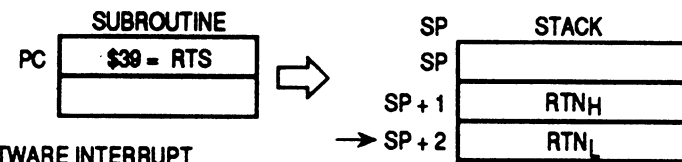

## SWI, SOFTWARE INTERRUPT

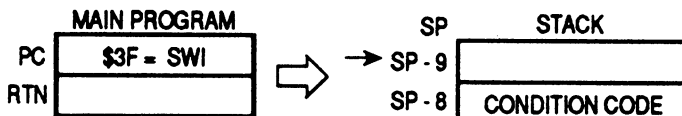

## WAI, WAIT FOR INTERRUPT

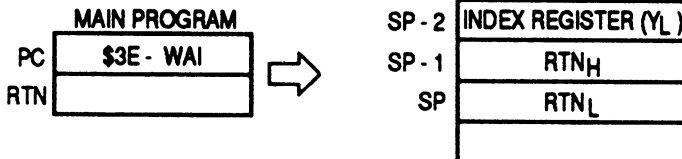

**For More Information On This Product,  
Go to: [www.freescale.com](http://www.freescale.com)**

# Freescale Semiconductor, Inc.

## SPECIAL OPERATIONS

### RTI, RETURN FROM INTERRUPT

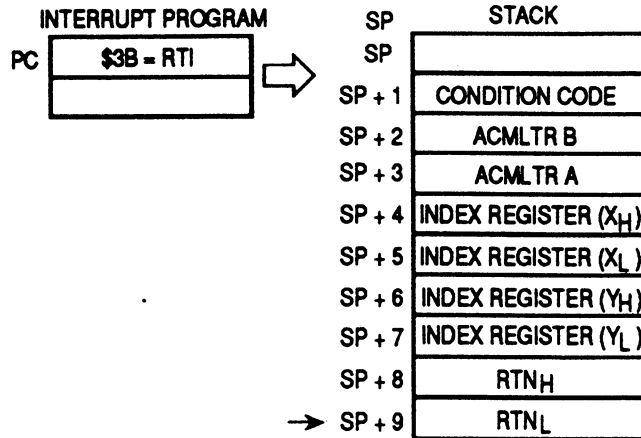

### JMP, JUMP

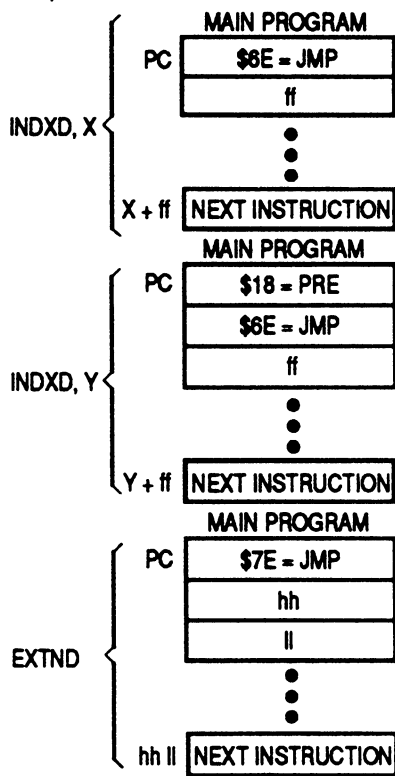

### LEGEND:

- RTN** Address of Next Instruction in Main Program To Be Executed upon Return from Subroutine
- RTN<sub>H</sub>** Most Significant Byte of Return Address
- RTN<sub>L</sub>** Least Significant Byte of Return Address
- Stack Pointer after Execution
- dd** 8-Bit Direct Address (\$0000-\$00FF) (High Byte Assumed To Be \$00)
- ff** 8-Bit Positive Offset \$00 (0) to \$FF (256) (Is Added to Index)
- hh** High-Order Byte of 16-Bit Extended Address
- ll** Low-Order Byte of 16-Bit Extended Address
- rr** Signed-Relative Offset \$80 ( - 128) to \$7F ( + 127) (Offset Relative to the Address Following the Machine Code Offset BYTE)

**For More Information On This Product,  
Go to: [www.freescale.com](http://www.freescale.com)**

# Freescale Semiconductor, Inc.

## REGISTER AND CONTROL BIT SUMMARY

	Bit 7	6	5	4	3	2	1	Bit 0	
\$0000	PA7	PA6	PA5	PA4	PA3	PA2	PA1	PA0	PORTA
\$0001									Reserved
\$0002			CWOM						PIOC
\$0003	PC7	PC6	PC5	PC4	PC3	PC2	PC1	PC0	PORTC
\$0004	PB7	PB6	PB5	PB4	PB3	PB2	PB1	PB0	PORTB
\$0005									Reserved
\$0006	DDB7	DDB6	DDB5	DDB4	DDB3	DDB2	DDB1	DDB0	DDR8
\$0007	DDC7	DDC6	DDC5	DDC4	DDC3	DDC2	DDC1	DDC0	DDRC
\$0008	PD7	PB6	PD5	PD4	PD3	PD2	PD1	PD0	PORTD
\$0009	DDD7	DDD6	DDD5	DDD4	DDD3	DDD2	DDD1	DDD0	DDR8
\$000A									Reserved
\$000B	FOC1	FOC2	FOC3	FOC4	FOC5	0	0	0	CFORC
\$000C	OC1M7	OC1M6	OC1M5	OC1M4	OC1M3	0	0	0	OC1M
\$000D	OC1D7	OC1D6	OC1D5	OC1D4	OC1D3	0	0	0	OC1D
\$000E	Bit 15	Bit 14	Bit 13	Bit 12	Bit 11	Bit 10	Bit 9	Bit 8	TCNT
\$000F	Bit 7	Bit 6	Bit 5	Bit 4	Bit 3	Bit 2	Bit 1	Bit 0	
\$0010	Bit 15	Bit 14	Bit 13	Bit 12	Bit 11	Bit 10	Bit 9	Bit 8	TIC1
\$0011	Bit 7	Bit 6	Bit 5	Bit 4	Bit 3	Bit 2	Bit 1	Bit 0	
\$0012	Bit 15	Bit 14	Bit 13	Bit 12	Bit 11	Bit 10	Bit 9	Bit 8	TIC2
\$0013	Bit 7	Bit 6	Bit 5	Bit 4	Bit 3	Bit 2	Bit 1	Bit 0	
\$0014	Bit 15	Bit 14	Bit 13	Bit 12	Bit 11	Bit 10	Bit 9	Bit 8	TIC3
\$0015	Bit 7	Bit 6	Bit 5	Bit 4	Bit 3	Bit 2	Bit 1	Bit 0	
\$0016	Bit 15	Bit 14	Bit 13	Bit 12	Bit 11	Bit 10	Bit 9	Bit 8	TOC1
\$0017	Bit 7	Bit 6	Bit 5	Bit 4	Bit 3	Bit 2	Bit 1	Bit 0	
\$0018	Bit 15	Bit 14	Bit 13	Bit 12	Bit 11	Bit 10	Bit 9	Bit 8	TOC2
\$0019	Bit 7	Bit 6	Bit 5	Bit 4	Bit 3	Bit 2	Bit 1	Bit 0	
\$001A	Bit 15	Bit 14	Bit 13	Bit 12	Bit 11	Bit 10	Bit 9	Bit 8	TOC3
\$001B	Bit 7	Bit 6	Bit 5	Bit 4	Bit 3	Bit 2	Bit 1	Bit 0	
\$001C	Bit 15	Bit 14	Bit 13	Bit 12	Bit 11	Bit 10	Bit 9	Bit 8	TOC4
\$001D	Bit 7	Bit 6	Bit 5	Bit 4	Bit 3	Bit 2	Bit 1	Bit 0	
\$001E	Bit 15	Bit 14	Bit 13	Bit 12	Bit 11	Bit 10	Bit 9	Bit 8	TI405
\$001F	Bit 7	Bit 6	Bit 5	Bit 4	Bit 3	Bit 2	Bit 1	Bit 0	
\$0020	OL2	OL2	OL3	OL3	OL4	OL4	OL5	OL5	TCTL1

**For More Information On This Product,  
Go to: [www.freescale.com](http://www.freescale.com)**



# Freescale Semiconductor, Inc.

## REGISTER AND CONTROL BIT SUMMARY

\$0021	EDG4B	EDG4A	EDG1B	EDG1A	EDG2B	EDG2A	EDG3B	EDG3A	TCTL2
\$0022	OC1I	OC2I	OC3I	OC4I	I405I	IC1I	IC2I	IC3I	TMSK1
\$0023	OC1F	OC2F	OC3F	OC4F	I405F	IC1F	IC2F	IC3F	TFLG1
\$0024	TOI	RTII	PAOVI	PAII	0	0	PR1	PR0	TMSK2
\$0025	TOF	RTIF	PAOVF	PAIF	0	0	0	0	TFLG2
\$0026	DDRA7	PAEN	PAMOD	PEDGE	DDRA3	I4/O5	RTR1	RTR0	PACTL
\$0027	Bit 7	Bit 6	Bit 5	Bit 4	Bit 3	Bit 2	Bit 1	Bit 0	PACNT
\$0028	SPIE	SPE	DWOM	MSTR	CPOL	CPHA	SPR1	SPR0	SPCR
\$0029	SPIF	WCOL	0	MODF	0	0	0	0	SPSR
\$002A	Bit 7	Bit 6	Bit 5	Bit 4	Bit 3	Bit 2	Bit 1	Bit 0	SPDR
\$002B	TCLR	0	SCP1	SCP0	RCKB	SCR2	SCR1	SCR0	BAUD
\$002C	R8	T8	0	M	WAKE	0	0	0	SCCR1
\$002D	TIE	TCIE	RIE	ILIE	TE	RE	RWU	SBK	SCCR2
\$002E	TDRE	TC	RDRF	IDLE	OR	NF	FE	0	SCSR
\$002F	Bit 7	Bit 6	Bit 5	Bit 4	Bit 3	Bit 2	Bit 1	Bit 0	SCDR
\$0030									Reserved
to									
\$0038									Reserved
\$0039	0	0	IRQE	DLY	CME	0	CR1	CR0	OPTION
\$003A	Bit 7	Bit 6	Bit 5	Bit 4	Bit 3	Bit 2	Bit 1	Bit 0	COPRST
\$003B	MBE	0	ELAT	EXCOL	EXROW	0	0	PGM	PPROG*
\$003C	RBOOT	SMOD	MDA	IRVNE	PSEL3	PSEL2	PSEL1	PSEL0	HPRIO
\$003D	RAM3	RAM2	RAM1	RAM0	REG3	REG2	REG1	REG0	INIT
\$003E	TILOP	EPTST	OCCR	CBYP	DISR	FCM	FCOP	0	TEST1
\$003F	0	0	0	0	0	NOCOP	EPON**	0	CONFIG

\* — Not present in ROM-based MC68HC11D3

\*\* — ROMON in MC68HC11D3

### NOTE

The status and control register block is relocatable to any 4K boundary within the MC68HC711D3's 64K of addressable memory using the REG3–REG0 bits of the INIT register. Reset locates this block at \$0000–003F. The default value is indicated by the use of a bold 0 at the beginning of the address of any relocatable register.

**For More Information On This Product,  
Go to: [www.freescale.com](http://www.freescale.com)**

**SCI Baud Rate Control Register**

\$002B	TCLR	0	SCP1	SCP0	RCKB	SCR2	SCR1	SCR0
--------	------	---	------	------	------	------	------	------

RESET:    0    0    0    0    0    U    U    U

TCLR — Clear Baud Counter Chain (Test Only)

RCKB — SCI Baud Rate Clock Test (Test Only)

SCP1, SCP0 — Serial Prescaler Selects

S C P 1	S C P 0	Divide E By	Highest Baud Rate Xtal= 23	Highest Baud Rate Xtal= 8.0 MHz	Highest Baud Rate Xtal= 4.0 MHz
0	0	1	131.07 K	—	—
0	1	3	—	—	—
1	0	4	32.768 K	—	—
1	1	13	—	9600	4800
		E=	2.1 MHz	2.0 MHz	1.0 MHz

SCR2–SCR0 — SCI Rate Select Bit 2 Through Bit 0

S C R 2	S C R 1	S C R 0	Prescaler Output Divide-By Factor	Highest Baud Rate 32.768 K	Highest Baud Rate 9600	Highest Baud Rate 4800
0	0	0	1	32.768 K	9600	4800
0	0	1	2	—	4800	2400
0	1	0	4	8.192 K	2400	1200
0	1	1	8	—	1200	600
1	0	0	16	2.048 K	600	300
1	0	1	32	—	300	—
1	1	0	64	512	—	—
1	1	1	128	—	—	—

**Timer Compare Force Register**

\$000B	FOC1	FOC2	FOC3	FOC4	FOC5	0	0	0
--------	------	------	------	------	------	---	---	---

RESET: 0 0 0 0 0 0 0 0

Write 1's to force compare(s).

**CONFIG**

**Configuration Control Register**

The configuration control register controls the presence of PROM in the memory map and enables the COP watchdog system.

\$003F	0	0	0	0	0	NOCOP	EPON†	0
--------	---	---	---	---	---	-------	-------	---

RESET: 0 0 0 0 0 \* \*

Bits 7–3 and 0 — Not implemented; always read zero.

**NOCOP — Computer Operating Properly System Disable**

This bit is cleared out of reset in normal modes (single chip and expanded), enabling the COP system. It is writable only once after reset in these modes (SMOD=0). In the special modes (test and bootstrap) (SMOD=1), this bit comes out of reset set and is writable any time.

- 1 = COP system is disabled.
- 0 = COP system is enabled; reset is forced on timeout.

**†EPON — PROM Enable (ROM Enable (ROMON) in the MC68HC11D3)**

This is the EPON bit in the MC68HC711D3. In the MC68HC11D3, it is the ROMON bit. In either case, the functionality is the same. This bit is set out of reset, enabling the ROM or PROM in all modes. It is writable once in normal modes (SMOD=0), but is writable at any time in special modes (SMOD=1).

- 1 = PROM is present in the memory map.
- 0 = PROM is disabled from the memory map.

**NOTE**

In expanded mode out of reset, the ROM or PROM is located at \$7000–\$7FFF. In all other modes, the ROM or PROM resides at \$F000–\$FFFF.

**CONFIG**

**Arm/Reset COP Timer Circuitry**



Write \$55 and \$AA to reset COP watchdog timer.

**DDRB**

**Port B Data Direction Register**



RESET: 0 0 0 0 0 0 0 0

0 = Inputs

1 = Outputs

**DDRC**

**Port C Data Direction Register**



RESET: 0 0 0 0 0 0 0 0

0 = Inputs

1 = Outputs

**DDRD**

**Port D Data Direction Register**



RESET: 0 0 0 0 0 0 0 0

0 = Inputs

1 = Outputs

### Highest Priority Interrupt and Misc.

Four bits of this register (PSEL3–PSEL0) are used to select one of the I-bit-related interrupt sources and to elevate it to the highest I-bit-masked position of the priority resolution circuit. In addition, four miscellaneous system control bits are included in this register.

\$003C	RBOOT	SMOD	MDA	IRVNE	PSEL3	PSEL2	PSEL1	PSEL0
--------	-------	------	-----	-------	-------	-------	-------	-------

RESET:      \*        \*        \*        \*        0        1        0        1

\* = The reset condition of bits 7, 6, 5, and 4 depends on the mode selected at power-up initialization.

**RBOOT — Read Bootstrap ROM**

This bit can be read at any time. It can only be written in special modes (SMOD = 1). In special bootstrap mode, it is set during reset. Reset clears it in all other modes.

1 = Bootloader ROM is enabled in the memory map at \$BF00–\$BFFF.

0 = Bootloader ROM is disabled and is not in the memory map.

**SMOD and MDA — Special Mode Select, Mode Select A**

These two bits can be read at any time. They may only be written in special modes (SMOD = 1). MDA may be written once with SMOD = 0. These bits reflect the status of the MODA and MODB input pins at the rising edge of reset. SMOD cannot be written to a one after being cleared without an interim reset. An interpretation of the values of these two bits is shown in the following table:

Input Pins		Mode Description	Latched at Reset	
MODB	MODA		SMOD	MDA
1	0	(0) Single Chip	0	0
1	1	(1) Expanded Multiplexed	0	1
0	0	Special Bootstrap	1	0
0	1	Special Test	1	1

# Freescale Semiconductor, Inc.

## HPRIO

### IRVNE — Internal Read Visibility Enable/Not E

This bit may be read at any time. It may only be written once. IRVNE is set during reset in special mode and is cleared by reset in all other modes.

Mode	IRVNE Out of Reset	E-Clock Out of Reset	IRV Out of Reset	IRVNE Affects Only
Single Chip	0	On	Off	E
Expanded	0	On	Off	IRV
Bootstrap	0	On	Off	E
Special Test	1	On	On	IRV

### PSEL3–PSEL0 — Priority Select Bits 3–0 (May only be written if I bit in CCR = 1)

PSEL3	PSEL2	PSEL1	PSEL0	Interrupt Source Promoted
0	0	0	0	Timer Overflow
0	0	0	1	Pulse Accumulator Overflow
0	0	1	0	Pulse Accumulator Input Edge
0	0	1	1	SPI Serial Transfer Complete
0	1	0	0	SCI Serial System
0	1	0	1	Reserved (Default to IRQ)
0	1	1	0	IRQ
0	1	1	1	Real-Time Interrupt
1	0	0	0	Timer Input Capture 1
1	0	0	1	Timer Input Capture 2
1	0	1	0	Timer Input Capture 3
1	0	1	1	Timer Output Compare 1
1	1	0	0	Timer Output Compare 2
1	1	0	1	Timer Output Compare 3
1	1	1	0	Timer Output Compare 4
1	1	1	1	Timer Input Capture 4/Output Compare 5

**RAM and I/O Mapping Register**

\$003D	RAM3	RAM2	RAM1	RAM0	REG3	REG2	REG1	REG0
--------	------	------	------	------	------	------	------	------

RESET: 0 0 0 0 0 0 0 0

(Time protected)

RAM3–RAM0 — RAM Map Position

REG3–REG0 — 64-Byte Register Block Map Position

**OC1D**

**Output Compare 1 Data Register**

\$000D	OC1D7	OC1D6	OC1D5	OC1D4	OC1D3	0	0	0
--------	-------	-------	-------	-------	-------	---	---	---

RESET: 0 0 0 0 0 0 0 0

If OC1Mx is set, data in OC1Dx is output to port A bit x on successful OC1 compares.

**OC1M**

**Output Compare 1 Mask Register**

\$000C	OC1M7	OC1M6	OC1M5	OC1M4	OC1M3	0	0	0
--------	-------	-------	-------	-------	-------	---	---	---

RESET: 0 0 0 0 0 0 0 0

REF: PAI/ OC2/ OC3/ OC4/ OC5/IC4  
OC1 OC1 OC1 OC1 OC1

Set bit(s) to enable OC1 to control corresponding pin(s) of port A.

# Freescale Semiconductor, Inc.

## OPTION

### System Configuration Options

\$0039	0	0	IRQE	DLY	CME	0	CR1	CR0
--------	---	---	------	-----	-----	---	-----	-----

RESET: 0 0 0 1 0 0 0 0

Bits 7, 6, and 0 — Not implemented; always read zero.

IRQE —  $\overline{\text{IRQ}}$  Select Edge Sensitive Only (Time Protected)

0 =  $\overline{\text{IRQ}}$  configured for low-level sensitivity

1 =  $\overline{\text{IRQ}}$  configured for falling edge sensitivity

DLY — Enable Oscillator Startup Delay (On Exit from STOP)  
(Time Protected)

0 = No startup delay

1 = A delay is imposed

CME — Clock Monitor Enable

0 = Disabled

1 = Slow or stopped clocks cause reset

CR1, CR0 — COP Timer Rate Select Bits  
(Time Protected)

C R 1	C R 0	E/2 <sup>15</sup> Divided By	Xtal = 2 <sup>23</sup> Timeout – 0/+ 15.6 ms	Xtal = 8.0 MHz Timeout – 0/+ 16.4 ms	Xtal = 4.0 MHz Timeout – 0/+ 32.8 ms
0	0	1	15.625 ms	16.384 ms	32.768 ms
0	1	4	62.5 ms	65.536 ms	131.07 ms
1	0	16	250 ms	262.14 ms	524.29 ms
1	1	64	1 s	1.049 s	2.1 s
		E =	2.1 MHz	2.0 MHz	1.0 MHz

## PACNT

### Pulse Accumulator Count Register

\$0027	PCNT7	PCNT6	PCNT5	PCNT4	PCNT3	PCNT2	PCNT1	PCNT0
--------	-------	-------	-------	-------	-------	-------	-------	-------

(Readable and writable; unaffected by reset)

**PACNT** For More Information On This Product,  
Go to: [www.freescale.com](http://www.freescale.com)



**Pulse Accumulator Control Register**

\$0026	0	PAEN	PAMOD	PEDGE	DDRA3	I4/O5	RTR1	RTR0
--------	---	------	-------	-------	-------	-------	------	------

RESET: 0 0 0 0 0 0 0 0

PAEN — Pulse Accumulator System Enable  
 0 = Disabled  
 1 = Enabled

PAMOD — Pulse Accumulator Mode  
 0 = Event counter  
 1 = Gated time accumulation

PEDGE — Pulse Accumulator Edge Control  
 0 = Falling edges, high level enables accumulation  
 1 = Rising edges, low level enables accumulation

DDRA3 — Data Direction Control for Port A Bit 3  
 1 = PA3 is an output.  
 0 = PA3 is an input only.

I4/O5 — Input Capture 4/Output Compare 5  
 0 = Output compare 5 function enable (no IC4)  
 1 = Input capture 4 function enable (no OC5)

RTR1, RTR0 — RTI Interrupt Rate

R T R 1	R T R 0	Divide E By	Xtal= 2 <sup>23</sup>	Xtal= 8.0 MHz	Xtal= 4.0 MHz
0	0	2 <sup>13</sup>	3.91 ms	4.10 ms	8.19 ms
0	1	2 <sup>14</sup>	7.81 ms	8.19 ms	16.38 ms
1	0	2 <sup>15</sup>	15.62 ms	16.38 ms	32.77 ms
1	1	2 <sup>16</sup>	31.25 ms	32.77 ms	65.54 ms
		E =	2.1 MHz	2.0 MHz	1.0 MHz

Freescale Semiconductor, Inc.

# Freescale Semiconductor, Inc.

## PIOC

### Parallel I/O Control Register

\$0002	0	0	CWOM	0	0	0	0	0
--------	---	---	------	---	---	---	---	---

RESET: 0 0 0 0 0 0 0 0

CWOM — Port C Wired-OR Mode Option Bit  
 1 = All port C outputs act as open-drain outputs.  
 0 = All port C outputs are normal CMOS outputs.

Bits 7, 6, 4–0 are not used in this register.

## PORTA

### Port A Data Register

\$0000	PA7	PA6*	PA5	PA4*	PA3	PA2	PA1	PA0
--------	-----	------	-----	------	-----	-----	-----	-----

RESET: HiZ 0 0 0 HiZ HiZ HiZ HiZ

REF. PAI/ OC2/ OC3/ OC4/ OC5/IC4 IC1 IC2 IC3  
 OC1 OC1 OC1 OC1 OC1

\*Not bonded on 40-pin DIP.

## PORTB

### Port B Data Register

\$0004	PB7	PB6	PB5	PB4	PB3	PB2	PB1	PB0
--------	-----	-----	-----	-----	-----	-----	-----	-----

MODE 0 PB7 PB6 PB5 PB4 PB3 PB2 PB1 PB0  
 or BOOT (RESET to HiZ inputs)

MODE 1 A15 A14 A13 A12 A11 A10 A9 A8  
 or TEST (ADDRESS outputs during RESET)

**Port C Data Register**

<b>\$0003</b>	PC7	PC6	PC5	PC4	PC3	PC2	PC1	PC0
<b>MODE 0 or BOOT</b>	PC7	PC6	PC5	PC4	PC3	PC2	PC1	PC0
	(RESET to HiZ inputs)							
<b>MODE 1 or TEST</b>	A7/ D7	A6/ D6	A5/ D5	A4/ D4	A3/ D3	A2/ D2	A1/ D1	A0/ D0
	(Multiplexed address/data outputs during RESET)							

**PORTD**

**Port D Data Register**

<b>\$0008</b>	PD7	PD6	PD5	PD4	PD3	PD2	PD1	PD0
<b>MODE 0 or BOOT</b>	PD7	PD6	PD5	PD4	PD3	PD2	PD1	PD0
	(RESET to HiZ inputs)							
<b>MODE 1 or TEST</b>	<u>R/W</u>	<u>AS</u>	<u>PD5</u>	<u>PD4</u>	<u>PD3</u>	<u>PD2</u>	<u>PD1</u>	<u>PD0</u>
	Outputs		(RESET to HiZ inputs)					
<b>REF.</b>			$\overline{SS}$	SCK	MOSI	MISO	TxD	RxD

Freescale Semiconductor, Inc.



**PORTD**

**EPROM Programming Control Register**

This register is used to control the programming of the PROM. PPROG is cleared on reset so that the PROM is configured for normal read.

\$003B	MBE	0	ELAT	EXCOL	EXROW	0	0	PGM
--------	-----	---	------	-------	-------	---	---	-----

RESET:    0        0        0        0        0        0        0        0

**MBE** — Multiple Byte Program Enable  
 This bit is reserved for testing.

Bits 6, 2, and 1 — Not implemented; always read zero.

**ELAT** — EPROM (OTEPROM) Latch Control  
 1 = PROM address and data bus are configured for programming. Writes to PROM cause address and data to be latched. The PROM cannot be read.  
 0 = PROM address and data bus configured for normal reads. PROM cannot be programmed.

**EXCOL** — Select Extra Columns  
 This bit is reserved for testing.

**EXROW** — Select Extra Row  
 This bit is reserved for testing.

**PGM** — EPROM (OTEPROM) Program Command  
 This bit may be written only when ELAT = 1.  
 1 = Programming power is switched on to PROM array.  
 0 = Programming power is switched off.

**NOTE**

This is an unused location in the ROM-based MC68HC11D3.

SCI Control Register 1

\$002C	R8	T8	0	M	WAKE	0	0	0
--------	----	----	---	---	------	---	---	---

RESET:    U    U    0    0    0    0    0    0

R8 — Receive Bit 8

T8 — Transmit Bit 8

M — Mode (Select Character Format)  
 0 = 1 start, 8 data, 1 stop bit  
 1 = 1 start, 8 data, ninth data, 1 stop bit

WAKE — Wakeup (By Address Mark/Idle)  
 0 = Wakeup by idle line  
 1 = Wakeup by address mark

SCCR2

SCI Control Register 2

\$002D	TIE	TCIE	RIE	ILIE	TE	RE	RWU	SBK
--------	-----	------	-----	------	----	----	-----	-----

RESET:    0    0    0    0    0    0    0    0

TIE — Transmit Interrupt Enable

TCIE — Transmit Complete Interrupt Enable

RIE — Receiver Interrupt Enable

ILIE — Idle-Line Interrupt Enable  
 0 = Inhibit interrupts  
 1 = Enable interrupts

TE — Transmitter Enable  
 (Toggle to queue idle character.)

RE — Receiver Enable  
 0 = Off  
 1 = On

RWU — Receiver Wakeup Control  
 0 = Normal  
 1 = Receiver asleep

SBK — Send Break

**Freescale Semiconductor, Inc.**  
**SCDR**

**SCI Data Register**

\$002F	R7/T7	R6/T6	R5/T5	R4/T4	R3/T3	R2/T2	R1/T1	R0/T0
--------	-------	-------	-------	-------	-------	-------	-------	-------

(Receive and transmit double buffered)

**SCSR**

**SCI Status Register**

\$002E	TDRE	TC	RDRF	IDLE	OR	NF	FE	0
--------	------	----	------	------	----	----	----	---

RESET:    1    1    0    0    0    0    0    0

TDRE — Transmit Data Register Empty Flag

TC — Transmit Complete Flag

RDRF — Receive Data Register Full Flag

IDLE — Idle Line Detected Flag

OR — Overrun Error Flag

NF — Noise Error Flag

FE — Framing Error Flag



**SPI Control Register**

\$0028	SPIE	SPE	DWOM	MSTR	CPOL	CPHA	SPR1	SPR0
--------	------	-----	------	------	------	------	------	------

RESET: 0 0 0 0 0 1 U U

SPIE — SPI Interrupt Enable

SPE — SPI System Enable

DWOM — Port D Wired-OR Mode

0 = Port D output normal

1 = Open drain (Bits 5–0 only)

MSTR — Master/Slave Mode Select

0 = Slave mode

1 = Master mode

CPOL — Clock Polarity

CPHA — Clock Phase

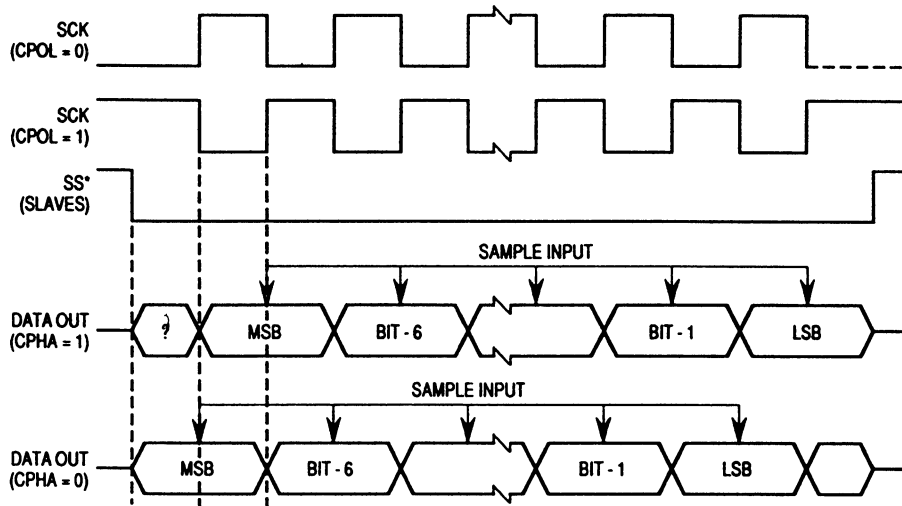

SPR1, SPR0 — SPI Clock (SCK)  
Rate Select Bits

SPR1	SPR0	E-Clock Divided By
0	0	2
0	1	4
1	0	16
1	1	32

**SPCR**

For More Information On This Product,  
Go to: [www.freescale.com](http://www.freescale.com)

**SPI Data Register**

\$002A	SPD7	SPD6	SPD5	SPD4	SPD3	SPD2	SPD1	SPD0
--------	------	------	------	------	------	------	------	------

(Double buffered in, single buffered out)

**SPSR**

**SPI Status Register**

\$0029	SPIF	WCOL	0	MODF	0	0	0	0
--------	------	------	---	------	---	---	---	---

RESET: 0 0 0 0 0 0 0 0

SPIF — SPI Interrupt Request

WCOL — Write Collision Status Flag

MODF — SPI Mode Error Interrupt Status Flag

**TCNT**

**Timer Count Register**

	B7	TCNT (HIGH)						B0
\$000E	CNT15	CNT14	CNT13	CNT12	CNT11	CNT10	CNT9	CNT8

	B7	TCNT (LOW)						B0
\$000F	CNT7	CNT6	CNT5	CNT4	CNT3	CNT2	CNT1	CNT0

RESET: \$0000 (Readable, not writable)

**TCNT**

For More Information On This Product,  
Go to: [www.freescale.com](http://www.freescale.com)



**Timer Control Register 1**

\$0020	OM2	OL2	OM3	OL3	OM4	OL4	OM5	OL5
--------	-----	-----	-----	-----	-----	-----	-----	-----

RESET: 0 0 0 0 0 0 0 0

OMx	OLx	Action Taken Upon Successful Compare
0	0	Timer Disconnected from Output Pin Logic
0	1	Toggle OCx Output Line
1	0	Clear OCx Output Line to Zero
1	1	Set OCx Output Line to One

**TCTL2**

**Timer Control Register 2**

\$0021	EDG4B	EDG4A	EDG1B	EDG1A	EDG2B	EDG2A	EDG3B	EDG3A
--------	-------	-------	-------	-------	-------	-------	-------	-------

RESET: 0 0 0 0 0 0 0 0

Timer input capture edge specifications:

EDGxB	EDGxA	Configuration
0	0	Capture Disabled
0	1	Capture on Rising Edges Only
1	0	Capture on Falling Edges Only
1	1	Capture on Any Edge (Rising or Falling)



**TCTL2**

# TFLG2 Freescale Semiconductor, Inc.

## Main Timer Interrupt Flag Reg. 1

\$0023	OC1F	OC2F	OC3F	OC4F	I4O5F	IC1F	IC2F	IC3F
--------	------	------	------	------	-------	------	------	------

RESET:     0     0     0     0     0     0     0     0

OC1F–OC4F — Output Compare “x” Flag

I4O5F — Input Capture 4 or Output Compare 5 Flag

IC1F–IC3F — Input Capture “x” Flag

(To clear flag(s), write with corresponding bit(s) set.)

1

## TFLG2

### Misc. Timer Interrupt Flag Reg. 2

\$0025	TOF	RTIF	PAOVF	PAIF	0	0	0	0
--------	-----	------	-------	------	---	---	---	---

RESET:     0     0     0     0     0     0     0     0

TOF — Timer Overflow Flag

RTIF — Real-Time (Periodic) Interrupt Flag

PAOVF — Pulse Accumulator Overflow Flag

PAIF — Pulse Accumulator Input Edge Flag

(To clear flag(s), write with corresponding bit(s) set.)



## TFLG2

For More Information On This Product,  
Go to: [www.freescale.com](http://www.freescale.com)

**Timer Input Capture Registers**

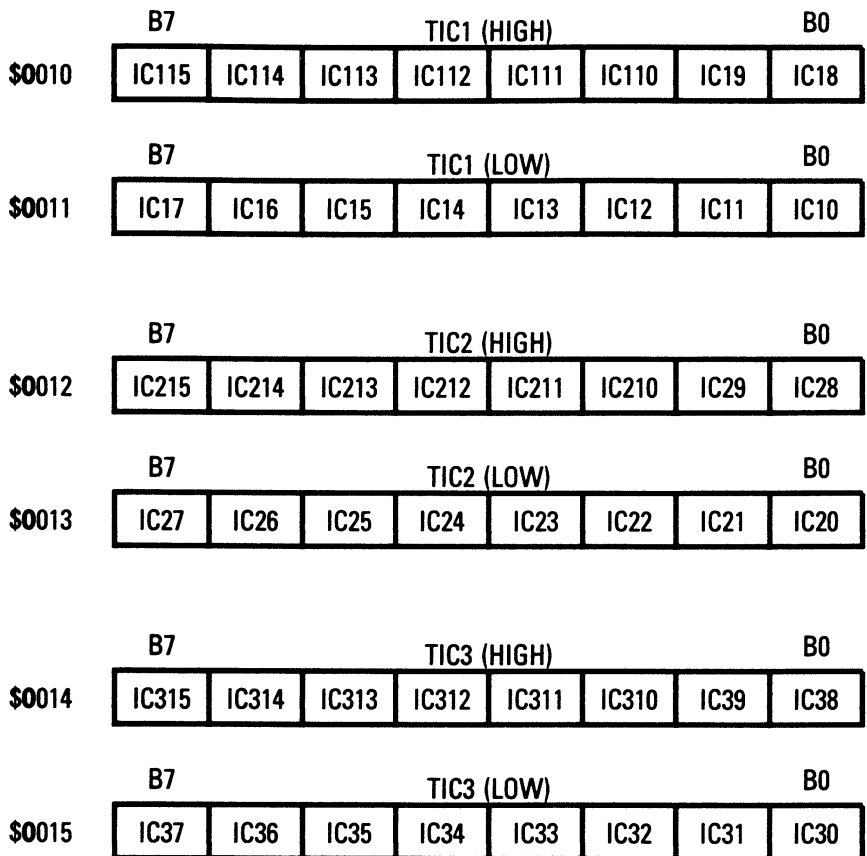

**TI405**



**Timer Input Capture 4 or Output Compare 5 Register**

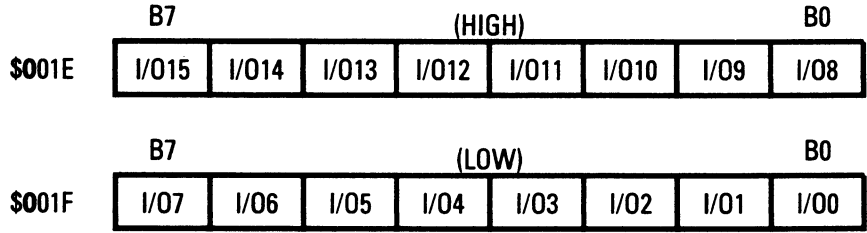

**TI405**

# TMSK1 Freescale Semiconductor, Inc.

## Main Timer Interrupt Mask Reg. 1

\$0022	OC1I	OC2I	OC3I	OC4I	I4O5I	IC1I	IC2I	IC3I
--------	------	------	------	------	-------	------	------	------

RESET:    0      0      0      0      0      0      0      0

OC1I–OC4I — Output Compare “x” Interrupt Enable

I4O5I — Input Capture 4 or Output Compare 5 Interrupt

IC1I–IC3I — Input Capture “x” Interrupt Enable

0 = Interrupt inhibited

1 = Interrupt requested if flag set

## TMSK2

### Misc. Timer Interrupt Mask Reg. 2

\$0024	TOI	RTII	PAOVI	PAII	0	0	PR1	PR0
--------	-----	------	-------	------	---	---	-----	-----

RESET:    0      0      0      0      0      0      0      0

TOI — Timer Overflow Interrupt Enable

RTII — RTI Interrupt Enable

PAOVI — Pulse Accumulator Overflow Interrupt Enable

PAII — Pulse Accumulator Input Interrupt Enable

0 = Interrupt inhibited

1 = Interrupt requested if flag set

PR1, PR0 — Timer Prescaler Select (Time Protected)

PR1	PR0	Prescale Factor
0	0	1
0	1	4
1	0	8
1	1	16

## TMSK2

For More Information On This Product,  
Go to: [www.freescale.com](http://www.freescale.com)

**Timer Output Compare Registers**

	B7	TOC1 (HIGH)						B0
\$0016	OC115	OC114	OC113	OC112	OC111	OC110	OC19	OC18

	B7	TOC1 (LOW)						B0
\$0017	OC17	OC16	OC15	OC14	OC13	OC12	OC11	OC10

	B7	TOC2 (HIGH)						B0
\$0018	OC215	OC214	OC213	OC212	OC211	OC210	OC29	OC28

	B7	TOC2 (LOW)						B0
\$0019	OC27	OC26	OC25	OC24	OC23	OC22	OC21	OC20

	B7	TOC3 (HIGH)						B0
\$001A	OC315	OC314	OC313	OC312	OC311	OC310	OC39	OC38

	B7	TOC3 (LOW)						B0
\$001B	OC37	OC36	OC35	OC34	OC33	OC32	OC31	OC30

	B7	TOC4 (HIGH)						B0
\$001C	OC415	OC414	OC413	OC412	OC411	OC410	OC49	OC48

	B7	TOC4 (LOW)						B0
\$001D	OC47	OC46	OC45	OC44	OC43	OC42	OC41	OC40



# PIN FUNCTIONS FOR EPROM EMULATION MODE

Freescale Semiconductor, Inc.

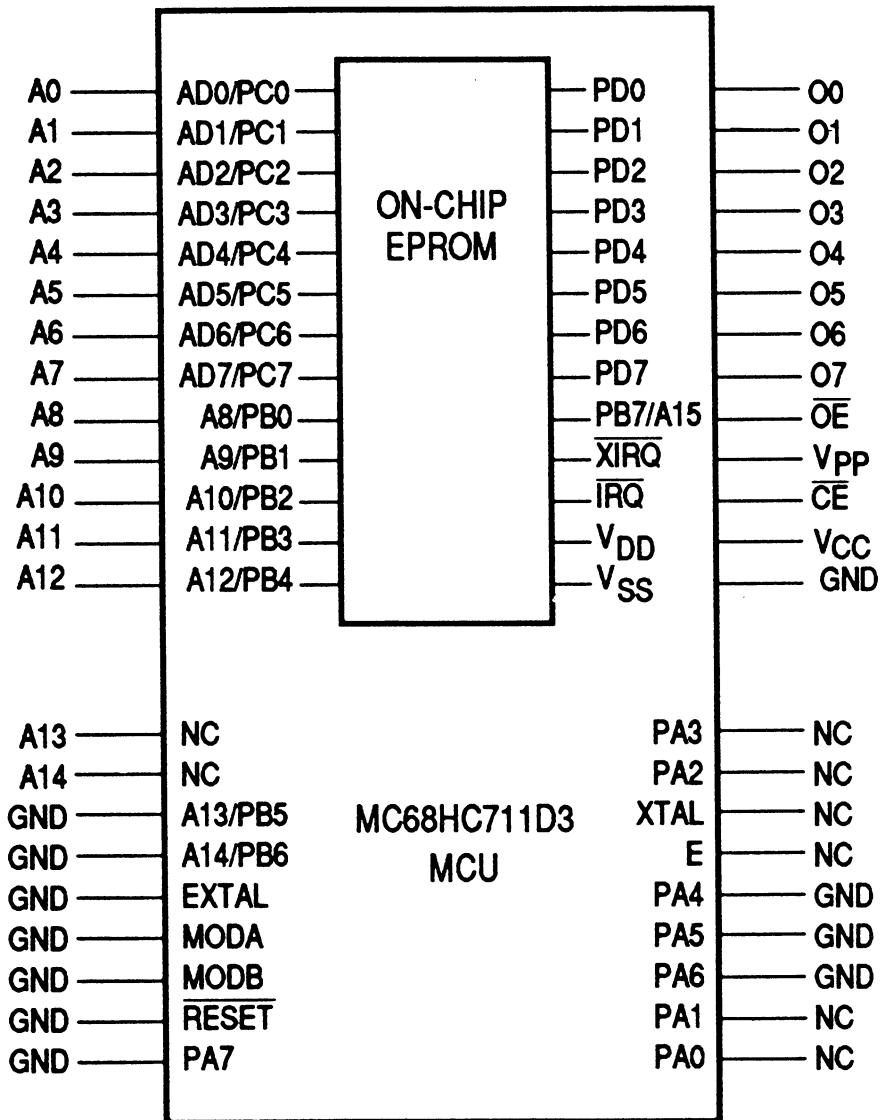

**Freescale Semiconductor, Inc.**  
**MC68HC711D3FN (OTPROM)**

**Freescale Semiconductor, Inc.**

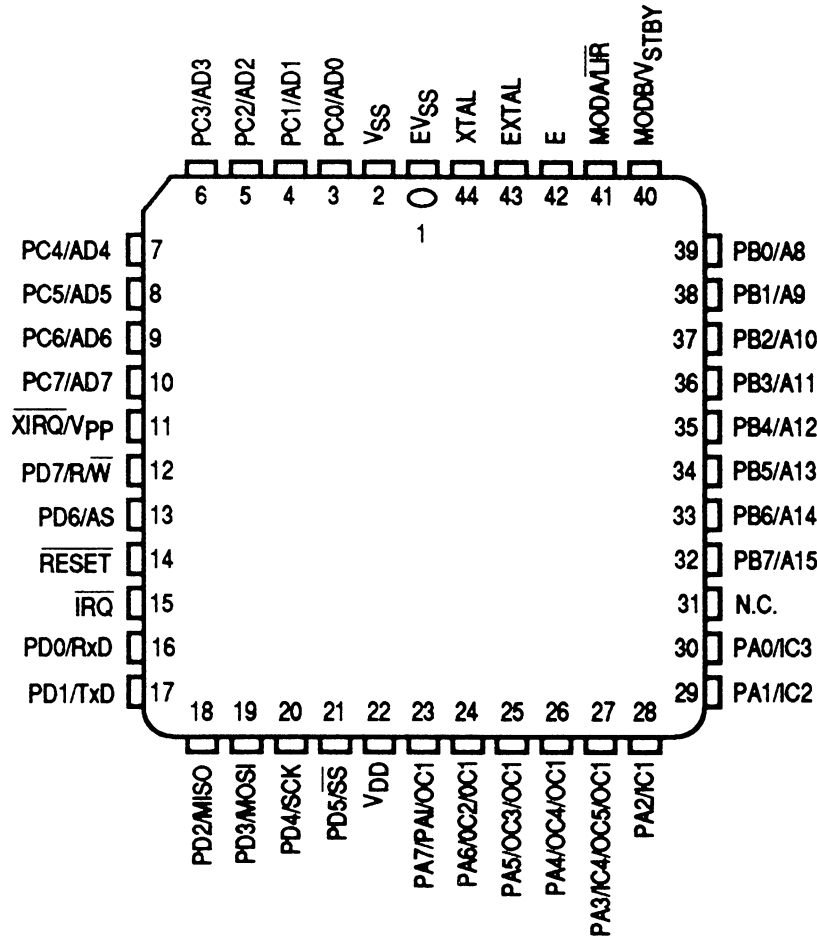

**For More Information On This Product,  
 Go to: [www.freescale.com](http://www.freescale.com)**

# MC68HC11D3P or MC68HC711D3P, Inc. (EPROM)

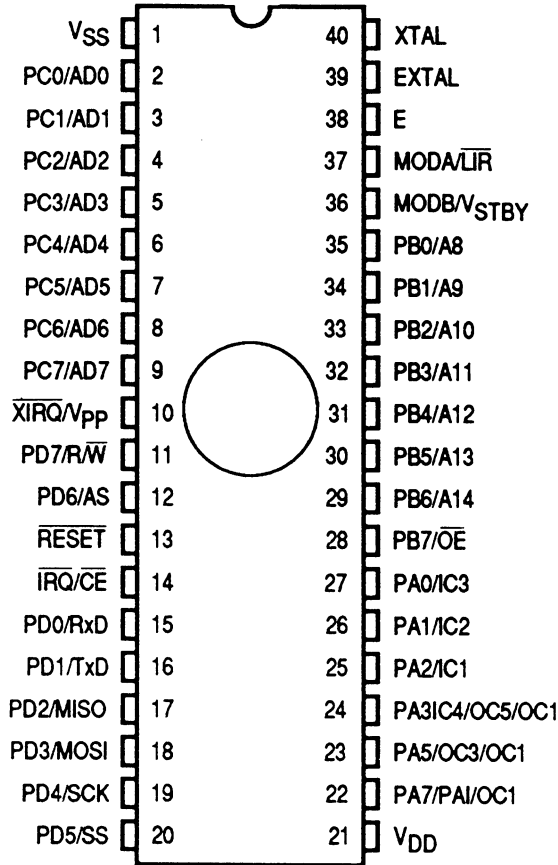

# MC68HC11D3P or MC68HC711D3P (OTPROM)

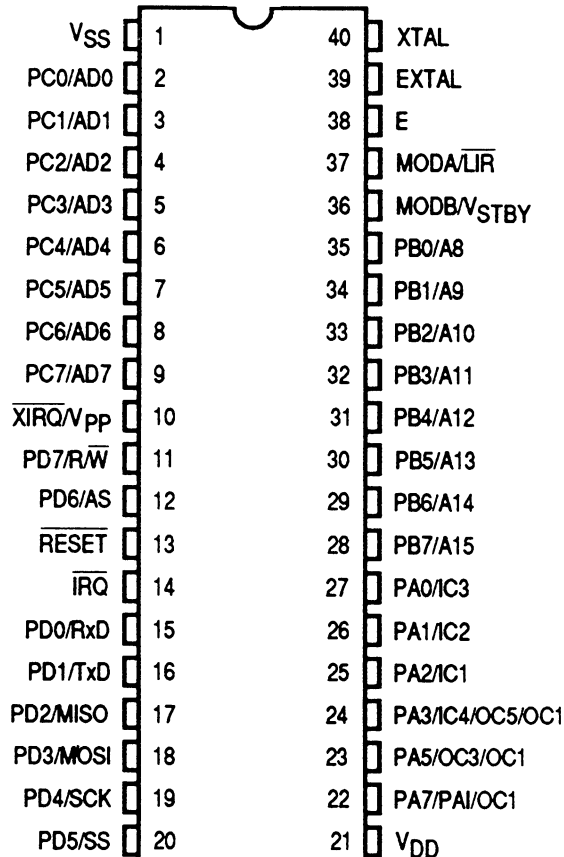

**For More Information On This Product,  
Go to: [www.freescale.com](http://www.freescale.com)**



## ASCII CHART

ASCII CHARACTER SET (7-Bit Code)	
MS Dig.	LS Dig.
0	NUL SOH STX ETX EOT ENQ ACK BEL BS HT LF VT FF CR SO SI
1	DLE DC1 DC2 DC3 DC4 NAK SYN ETB CAN EM SUB ESC FS GS RS US
2	SP !"#\$%&,'( ) * + , - . /
3	0 1 2 3 4 5 6 7 8 9 : ; < = > ?
4	@ A B C D E F G H I J K L M N O
5	P Q R S T U V W X Y Z [ \ ] ^ _
6	` a b c d e f g h i j k l m n o
7	p q r s t u v w x y z {   } ~ DEL



# HEXADECIMAL-AS-DIGIT-TO-DECIMAL CONVERSION

How to use:

Conversion to Decimal: Find the decimal weights for corresponding hexadecimal characters beginning with the least significant character. The sum of the decimal weights is the decimal value of the hexadecimal number.

Conversion to Hexadecimal: Find the highest decimal value in the table which is lower than or equal to the decimal number to be converted. The corresponding hexadecimal character is the most significant. Subtract the decimal value found from the decimal number to be converted. With the difference repeat the process to find subsequent hexadecimal characters.

15		Byte		8		7		Byte		0	
15	Char	12	11	Char	8	7	Char	4	3	Char	0
Hex	Dec	Hex	Dec	Hex	Dec	Hex	Dec	Hex	Dec	Hex	Dec
0	0	0	0	0	0	0	0	0	0	0	0
1	4,096	1	256	1	16	1	1	1	1	1	1
2	8,192	2	512	2	32	2	2	2	2	2	2
3	12,288	3	768	3	48	3	3	3	3	3	3
4	16,384	4	1,024	4	64	4	4	4	4	4	4
5	20,480	5	1,280	5	80	5	5	5	5	5	5
6	24,576	6	1,536	6	96	6	6	6	6	6	6
7	28,672	7	1,792	7	112	7	7	7	7	7	7
8	32,768	8	2,048	8	128	8	8	8	8	8	8
9	36,864	9	2,304	9	144	9	9	9	9	9	9
A	40,960	A	2,560	A	160	A	A	A	A	A	10
B	45,056	B	2,816	B	176	B	B	B	B	B	11
C	49,152	C	3,072	C	192	C	C	C	C	C	12
D	53,248	D	3,328	D	208	D	D	D	D	D	13
E	57,344	E	3,584	E	224	E	E	E	E	E	14
F	61,440	F	3,840	F	240	F	F	F	F	F	15





**PROGRAMMING MODEL  
CRYSTAL DEPENDENT TIMING  
INTERRUPTS**

**MEMORY MAP  
OPCODE MAPS**

**INSTRUCTIONS  
ADDRESSING MODES  
EXECUTION TIMES  
SPECIAL OPERATIONS**

**REGISTER AND  
CONTROL BIT  
ASSIGNMENTS**

**MECHANICAL DATA  
HEX/DEC CONVERSION  
ASCII CHART**

**PROGRAMMING MODEL  
CRYSTAL DEPENDENT TIMING  
INTERRUPTS**

**MEMORY MAP  
OPCODE MAPS**

**INSTRUCTIONS  
ADDRESSING MODES  
EXECUTION TIMES  
SPECIAL OPERATIONS**

**REGISTER AND  
CONTROL BIT  
ASSIGNMENTS**

**MECHANICAL DATA  
HEX/DEC CONVERSION  
ASCII CHART**

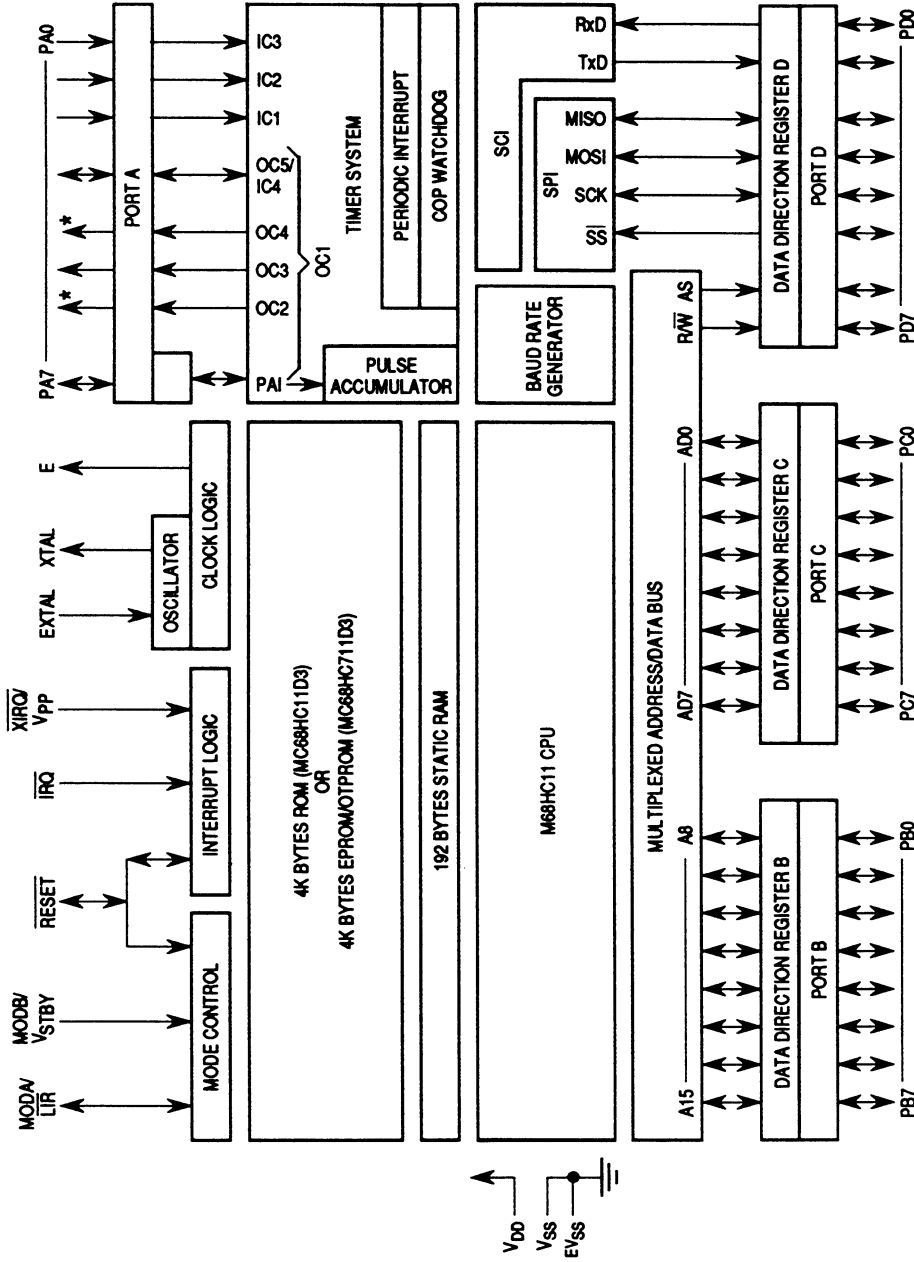

\*PA6 and PA4 not bonded in 40 pin DIP

Motorola reserves the right to make changes without further notice to any products herein to improve reliability, function or design. Motorola does not assume any liability arising out of the application or use of any product or circuit described herein; neither does it convey any license under its patent rights nor the rights of others. Motorola products are not authorized for use as components in life support devices or systems intended for surgical implant into the body or intended to support or sustain life. Buyer agrees to notify Motorola of any such intended end use whereupon Motorola shall determine availability and suitability of its product or products for the use intended. Motorola and  are registered trademarks of Motorola, Inc. Motorola, Inc. is an Equal Employment Opportunity Affirmative Action Employer.

**Literature Distribution Centers:**

USA: Motorola Literature Distribution

P.O. Box 20912; Phoenix, Arizona 85036

EUROPE: Motorola Ltd.; European Literature Center

88 Tanners Drive, Blakelands, Milton Keynes, MK14 5BP, England

ASIA PACIFIC: Motorola Semiconductors H.K. Ltd.

P.O. Box 80300; Cheung Sha Wan Post Office; Kowloon Hong Kong

JAPAN: Nippon Motorola Ltd.

3-20-1 Minamiazabu, Minato-ku, Tokyo 106 Japan



**MOTOROLA**

**For More Information On This Product,  
Go to: [www.freescale.com](http://www.freescale.com)**